



WiFi data logger system · testo Saveris 2

Instruction manual



1 Contents

1	Contents	3
2	System	5
2.1	System overview.....	5
3	First steps	6
4	Licences	6
4.1	testo Saveris 2 App.....	6
5	WiFi data logger.....	8
5.1	Technical data	8
5.1.1	Measurement-specific data	8
5.1.2	General data.....	9
5.1.3	WiFi-specific data	10
5.1.4	Technical data for a secure wireless LAN.....	10
5.1.5	Authorizations.....	11
5.1.5.1	European Union, EFTA countries.....	12
5.1.5.2	USA/Canada.....	17
5.1.5.3	Japan	17
5.1.5.4	Australia.....	17
5.1.5.5	China.....	17
5.1.5.6	Korea	18
5.1.5.7	Russia.....	18
5.1.5.8	Chile.....	18
5.1.5.9	Singapore	18
5.1.5.10	Ukraine.....	18
5.1.5.11	United Arab Emirates.....	18
5.2	Safety and the environment.....	19
5.2.1	Safety	19
5.2.2	Protecting the environment	19
5.3	Wall bracket	20
5.4	Display and control elements.....	21
5.4.1	Overview	21
5.4.2	Display icons	22

6	User interface.....	23
7	Dashboard.....	25
7.1	Measuring points	25
7.2	Active alarms	25
8	Analysis & reports.....	25
8.1	Data analysis	25
8.2	Automatic reports.....	26
9	Alarms	27
9.1	Alarm list.....	27
9.2	Alarm settings.....	28
9.3	System warnings	29
10	Configuration	30
10.1	Users	30
10.2	User roles	31
10.3	Account ID	32
10.4	Measuring point groups.....	32
10.5	Areas	33
10.6	WiFi data loggers	34
10.7	Firmware updates.....	35
11	User management	35
11.1	User settings.....	35
11.2	Account information.....	35
11.3	Change password	35
11.4	Logoff.....	35
12	Command bar	36
12.1	Open Quick Start Guide	36
12.2	Open Online Help	36
12.3	Open system messages.....	36
13	System and status information.....	36
13.1	Display system status.....	36

2 System

2.1 System overview

The testo Saveris 2 WiFi data logger system is the modern solution for monitoring temperature and humidity values in storerooms and work rooms.

The system consists of WiFi data loggers and a Cloud data storage system. The testo Saveris 2 WiFi data loggers record temperature and humidity reliably at adjustable intervals and transmit the readings directly to the Testo Cloud via WLAN. The readings stored in the Cloud can be analyzed at any time, anywhere, using an internet-enabled smartphone, tablet or PC. Limit value violations are immediately reported via e-mail, or optionally via SMS.

Similarly, WiFi data loggers can be programmed via the Testo Cloud and analyses set up.

Record readings with WiFi data loggers

WLAN router (at customer site)

Save the readings in the Testo Cloud

Call up readings on any terminal device: PC, smartphone, tablet

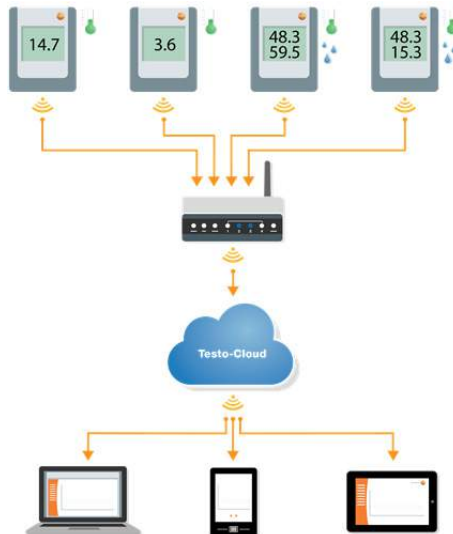

3 First steps

The Quick Start Guide is provided to assist you when you take your first steps with the testo Saveris 2.

It can help you with logging in WiFi data loggers.

- In the command bar, click on the icon  to open the **Quick Start Guide**.

4 Licences

When purchasing your Saveris 2 system you will receive a free basic licence.

Some measuring functions which are displayed in your Saveris 2 system are inactive. By expanding your licence you can activate and use these functions.

In the header you can see which licence you are currently using.

Purchase licence

By clicking on the licence display in the header you will be redirected to the licence shop. Here you can choose and purchase your licence expansion.

Or

Click on the symbol next to the inactive measuring function

 Upgrade. This also opens the licence shop to expand your licence.

4.1 testo Saveris 2 App

The testo App for the testo Saveris 2 monitoring system.

The free testo App offers you practical functions for commissioning, network analysis and receiving Saveris 2 push messages.

Specifications of the testo Saveris 2 App

Loggers are commissioned via the configuration wizard.

Note

In order to be able to establish a connection via WLAN, you need a tablet or smartphone with the Testo App already installed on it. You can get the App for Android devices in the Play Store.

Compatibility:

Requires Android 4.3 or later



Please note that, due to IOS system limitations, the network analysis and logger commissioning can only be carried out on Android devices

Network analysis

Use the network analysis to analyze your WLAN network in advance in order to check the requirements for operating the testo Saveris 2 loggers correctly.

You can also optionally create and send status reports.

Alerts

With the testo App, you can receive all Saveris 2 push alerts and see an overview.

Purchase the testo Saveris 2 App

This link will take you to the Google Play Store, where you can download the testo App onto your mobile terminal device free of charge.

5 WiFi data logger

5.1 Technical data

5.1.1 Measurement-specific data

WiFi data loggers	T1	T2	T3	H1	H2
Sensor type	1x NTC internal	2x NTC or door contact external	2x thermocouple type K/J/T external	1x NTC/humidity internal	1x NTC/humidity external
Measuring range	-30 to +50 °C	-50 to +150 °C	K: -195 to +1350 °C J: -100 to +750 °C T: -200 to +400 °C	-30 to +50 °C 0 to 100 %RH ¹	Probe-specific
Accuracy ±1 digit	± 0.5 °C	± 0.5 °C	± (0.5 °C + 0.5% of reading)	± 0.5 °C ±2 %RH	Probe-specific
Resolution	0.1 °C	0.1 °C	0.1 °C (-200 to +999.9 °C) 1 °C (residual range)	0.1 °C 0.1%	0.1 °C 0.1%

¹ Not for condensing atmosphere. For continuous application in high humidity (> 80 %RH at ≤ 30 °C for > 12 h, > 60 %RH at > 30 °C for > 12 h), please contact us (www.testo-international.com).

5.1.2 General data

WiFi data loggers	T1	T2	T3	H1	H2
Operating temperature	-30 to +50 °C				
Storage temperature (including batteries)	-40 to +70 °C				
Protection class	IP 65	IP 65	IP 54	IP 30	IP 54
Measurement rate	1 min to 24 h (15 minutes default)				
Communication rate	1 min to 24 h (15 minutes default)				
Memory	10,000 readings/channel				
Battery life	24 months ² at +25 °C, 15 min measuring cycle, 15 min day communication cycle (8 h/day) and 90 min night communication cycle (16 h/day) at -30 °C and 15 min measuring cycle, 15 min day communication cycle (8 h/day) and 90 min night communication cycle (16 h/day) with Energizer batteries 0515 0572				
Voltage supply	4 x AA AIMn batteries Mains unit optional for temperatures below -10 °C please use Energizer batteries 0515 0572				
Dimensions	95 x 75 x 30.5 mm				

² typical value, depending on the WLAN infrastructure

WiFi data loggers	T1	T2	T3	H1	H2
Weight (including batteries)	240 g				
EN 12830-compliant	Yes	Yes	No	No	No
Door contact	No	Optional	No	No	No
Wall bracket	Included in delivery				

5.1.3 WiFi-specific data

WiFi data loggers	T1	T2	T3	H1	H2
Radio frequency	2.4 GHz (IEEE 802.11 b/g/n)				
Encryption method	WEP, WPA (TKIP), WPA2 (TKIP, AES, CCMP)				

5.1.4 Technical data for a secure wireless LAN

Ports

The testo Saveris 2 WiFi data loggers use the MQTT protocol, which communicates via port TCP 1883.

These UDP port approvals are also required:

- Port 53 (DNS name resolution)
- Port 123 (NTP time synchronization)

All ports must be able to communicate only externally to the Cloud. No bi-directional port approvals are necessary.

Ping

The default gateway, which must be communicated to the probe via DHCP or manually, must answer the PING request of the WiFi data logger.

 **Note**

During the first configuration, it is possible to select whether DHCP or Static IP is used (select expert mode for the corresponding information)

testo Saveris 2 application

The testo Saveris 2 application is accessible via a normal, up-to-date browser (www). The standard TCP ports http (80) and https (443) are used.

5.1.5 Authorizations

Please note the following country-specific information for the product authorization.

5.1.5.1 European Union, EFTA countries

T1 (0572 2001):



EG-Konformitätserklärung

EC declaration of conformity

Für die nachfolgend bezeichneten Produkte:

We confirm that the following products:

testo Saveris 2 – T1

Best. Nr.: / Order No.: 0572 2001

wird bestätigt, daß sie den wesentlichen Schutzanforderungen entsprechen, die in der Richtlinie des Rates zur Angleichung der Rechtsvorschriften der Mitgliedstaaten über die **elektromagnetische Verträglichkeit** (2014/30/EU) festgelegt sind.

corresponds with the main protection requirements which are fixed in the EEC "Council Directive 2014/30 EU on the approximation of the laws of the member states relating to electromagnetic compatibility". The declaration applies to all samples of the above mentioned product.

Zur Beurteilung der Erzeugnisse hinsichtlich elektromagnetischer Verträglichkeit wurden folgende Normen herangezogen:

For assessment of the product following standards have been called upon:

Standards:

ETSI EN 300 328 V1.8.1: 2012
ETSI EN 301 489-01 V1.9.2: 2011
ETSI EN 301 489-17 V2.2.1: 2012

Diese Erklärung wird für:

This declaration is given in responsibility for:

Testo AG
Postfach / P.O. Box 1140
79849 Lenzkirch / Germany
www.testo.com

abgegeben durch / by:

Dr. Jörk Hebenstreit
(Name / name)

Uwe Haury
(Name / name)

Managing Director
(Stellung im Betrieb des Herstellers)
(Position in the company of the manufacturer)

Head of Electrical Engineering
(Stellung im Betrieb des Herstellers)
(Position in the company of the manufacturer)

Lenzkirch, 01.10.2014
(Ort, Datum / place, date)

(Rechtsgültige Unterschrift)
(Legally valid signature)

(Rechtsgültige Unterschrift)
(Legally valid signature)



Der Hersteller betreibt ein zertifiziertes Qualitätssicherungssystem nach DIN ISO 9001

The manufacturer operates a certified quality assurance system according to DIN ISO 9001

T2 (0572 2002):



Wir messen es.

**EG-Konformitätserklärung****EC declaration of conformity**

Für die nachfolgend bezeichneten Produkte:

We confirm that the following products:

testo Saveris 2 – T2

Best. Nr.: / Order No.: 0572 2002

wird bestätigt, daß sie den wesentlichen Schutzanforderungen entsprechen, die in der Richtlinie des Rates zur Angleichung der Rechtsvorschriften der Mitgliedstaaten über die **elektromagnetische Verträglichkeit** (2014/30/EU) festgelegt sind.

corresponds with the main protection requirements which are fixed in the EEC "Council Directive 2014/30 EU on the approximation of the laws of the member states relating to electromagnetic compatibility" The declaration applies to all samples of the above mentioned product.

Zur Beurteilung der Erzeugnisse hinsichtlich elektromagnetischer Verträglichkeit wurden folgende Normen herangezogen:

For assessment of the product following standards have been called upon:

Standards:

ETSI EN 300 328 V1.8.1: 2012
ETSI EN 301 489-01 V1.9.2: 2011
ETSI EN 301 489-17 V2.2.1: 2012

Diese Erklärung wird für:

This declaration is given in responsibility for:

Testo AG
Postfach / P.O. Box 1140
79849 Lenzkirch / Germany
www.testo.com

abgegeben durch / by:

Dr. Jörk Hebenstreit
 (Name / name)

Uwe Haury
 (Name / name)

Managing Director
 (Stellung im Betrieb des Herstellers)
 (Position in the company of the manufacturer)

Head of Electrical Engineering
 (Stellung im Betrieb des Herstellers)
 (Position in the company of the manufacturer)

Lenzkirch, 02.10.2014
 (Ort, Datum / place, date)

[Signature]
 (Rechtsgültige Unterschrift)
 (Legally valid signature)

[Signature]
 (Rechtsgültige Unterschrift)
 (Legally valid signature)



Der Hersteller betreibt ein zertifiziertes Qualitätssicherungssystem nach DIN ISO 9001

The manufacturer operates a certified quality assurance system according to DIN ISO 9001

T3 (0572 2003):



Wir messen es.



EG-Konformitätserklärung

EC declaration of conformity

Für die nachfolgend bezeichneten Produkte:

We confirm that the following products:

testo Saveris 2 – T3

Best. Nr.: / Order No.: 0572 2003

wird bestätigt, daß sie den wesentlichen Schutzanforderungen entsprechen, die in der Richtlinie des Rates zur Angleichung der Rechtsvorschriften der Mitgliedstaaten über die **elektromagnetische Verträglichkeit** (2014/30/EU) festgelegt sind.

corresponds with the main protection requirements which are fixed in the EEC "Council Directive 2014/30 EU on the approximation of the laws of the member states relating to electromagnetic compatibility" The declaration applies to all samples of the above mentioned product.

Zur Beurteilung der Erzeugnisse hinsichtlich elektromagnetischer Verträglichkeit wurden folgende Normen herangezogen:

For assessment of the product following standards have been called upon:

Standards:

**ETSI EN 300 328 V1.8.1: 2012
ETSI EN 301 489-01 V1.9.2: 2011
ETSI EN 301 489-17 V2.2.1: 2012**

Diese Erklärung wird für:

This declaration is given in responsibility for:

**Testo AG
Postfach / P.O. Box 1140
79849 Lenzkirch / Germany
www.testo.com**

abgegeben durch / by:

Dr. Jörk Hebenstreit
(Name / name)

Uwe Haury
(Name / name)

Managing Director
(Stellung im Betrieb des Herstellers)
(Position in the company of the manufacturer)

Head of Electrical Engineering
(Stellung im Betrieb des Herstellers)
(Position in the company of the manufacturer)

Lenzkirch, 02.10.2014
(Ort, Datum / place, date)

(Rechtsgültige Unterschrift)
(Legally valid signature)

(Rechtsgültige Unterschrift)
(Legally valid signature)



Der Hersteller betreibt ein zertifiziertes Qualitätssicherungssystem nach DIN ISO 9001

The manufacturer operates a certified quality assurance system according to DIN ISO 9001

H1 (0572 2004):



Wir messen es.

**EG-Konformitätserklärung****EC declaration of conformity**

Für die nachfolgend bezeichneten Produkte:

We confirm that the following products:

testo Saveris 2 – H1

Best. Nr.: / Order No.: 0572 2004

wird bestätigt, daß sie den wesentlichen Schutzanforderungen entsprechen, die in der Richtlinie des Rates zur Angleichung der Rechtsvorschriften der Mitgliedstaaten über die **elektromagnetische Verträglichkeit** (2014/30/EU) festgelegt sind.

corresponds with the main protection requirements which are fixed in the EEC "Council Directive 2014/30 EU on the approximation of the laws of the member states relating to electromagnetic compatibility" The declaration applies to all samples of the above mentioned product.

Zur Beurteilung der Erzeugnisse hinsichtlich elektromagnetischer Verträglichkeit wurden folgende Normen herangezogen:

For assessment of the product following standards have been called upon:

Standards:

ETSI EN 300 328 V1.8.1: 2012
ETSI EN 301 489-01 V1.9.2: 2011
ETSI EN 301 489-17 V2.2.1: 2012

Diese Erklärung wird für:

This declaration is given in responsibility for:

Testo AG
Postfach / P.O. Box 1140
79849 Lenzkirch / Germany
www.testo.com

abgegeben durch / by:

Dr. Jörk Hebenstreit
 (Name / name)

Uwe Haury
 (Name / name)

Managing Director
 (Stellung im Betrieb des Herstellers)
 (Position in the company of the manufacturer)

Head of Electrical Engineering
 (Stellung im Betrieb des Herstellers)
 (Position in the company of the manufacturer)

Lenzkirch, 01.10.2014
 (Ort, Datum / place, date)

(Rechtsgültige Unterschrift)
 (Legally valid signature)

(Rechtsgültige Unterschrift)
 (Legally valid signature)



Der Hersteller betreibt ein zertifiziertes Qualitätssicherungssystem nach DIN ISO 9001

The manufacturer operates a certified quality assurance system according to DIN ISO 9001

H2 (0572 2005):



EG-Konformitätserklärung

EC declaration of conformity

Für die nachfolgend bezeichneten Produkte:

We confirm that the following products:

testo Saveris 2 – H2

Best. Nr.: / Order No.: 0572 2005

wird bestätigt, daß sie den wesentlichen Schutzanforderungen entsprechen, die in der Richtlinie des Rates zur Angleichung der Rechtsvorschriften der Mitgliedstaaten über die **elektromagnetische Verträglichkeit** (2014/30/EU) festgelegt sind.

corresponds with the main protection requirements which are fixed in the EEC "Council Directive 2014/30 EU on the approximation of the laws of the member states relating to electromagnetic compatibility" The declaration applies to all samples of the above mentioned product.

Zur Beurteilung der Erzeugnisse hinsichtlich elektromagnetischer Verträglichkeit wurden folgende Normen herangezogen:

For assessment of the product following standards have been called upon:

Standards:

**ETSI EN 300 328 V1.8.1: 2012
ETSI EN 301 489-01 V1.9.2: 2011
ETSI EN 301 489-17 V2.2.1: 2012**

Diese Erklärung wird für:

This declaration is given in responsibility for:

**Testo AG
Postfach / P.O. Box 1140
79849 Lenzkirch / Germany
www.testo.com**

abgegeben durch / by:

Dr. Jörk Hebenstreit
(Name / name)

Uwe Haury
(Name / name)

Managing Director
(Stellung im Betrieb des Herstellers)
(Position in the company of the manufacturer)

Head of Electrical Engineering
(Stellung im Betrieb des Herstellers)
(Position in the company of the manufacturer)

Lenzkirch, 02.10.2014
(Ort, Datum / place, date)

(Rechtsgültige Unterschrift)
(Legally valid signature)

(Rechtsgültige Unterschrift)
(Legally valid signature)



Der Hersteller betreibt ein zertifiziertes Qualitätssicherungssystem nach DIN ISO 9001

The manufacturer operates a certified quality assurance system according to DIN ISO 9001

5.1.5.2 USA/Canada

This instrument complies with Part 15C of the FCC Rules and Industry Canada RSS-210 (revision 8). Commissioning is subject to the following two conditions: (1) This instrument must not cause any harmful interference and (2) this instrument must be able to cope with interference, even if this has undesirable effects on operation.

5.1.5.3 Japan

T1 (0572 2001):  204-440017

T2 (0572 2002):  204-440018

T3 (0572 2003):  204-440019

H1 (0572 2004):  204-440020

H2 (0572 2005):  204-440021

5.1.5.4 Australia



5.1.5.5 China

T1 (0572 2001): CMIIT ID: 2014DP5734

T2 (0572 2002): CMIIT ID: 2014DP5735

T3 (0572 2003): CMIIT ID: 2014DP5736

H1 (0572 2004): CMIIT ID: 2014DP5732

H2 (0572 2005): CMIIT ID: 2014DP5733

5.1.5.6 Korea



Instrument model	Saveris 2 T1	Saveris 2 T2	Saveris 2 T3	Saveris 2 H1	Saveris 2 H2
Identification number	MSIP-CRM-Toi-Saveris2 T1	MSIP-CRM-Toi-Saveris2 T2	MSIP-CRM-Toi-Saveris2 T3	MSIP-CRM-Toi-Saveris2 H1	MSIP-CRM-Toi-Saveris2 H2
Applicant	Testo Instruments (Shenzen) Co., Ltd.				
Manufacturer	Testo Instruments (Shenzen) Co., Ltd.				
Country of manufacture	China				
Note	해당 무선 설비는 운용 중 전파혼신 가능성이 있음				

5.1.5.7 Russia

Authorized.

5.1.5.8 Chile

Authorized.

5.1.5.9 Singapore

Authorized.

5.1.5.10 Ukraine

Authorized.

5.1.5.11 United Arab Emirates

Authorized.

5.2 Safety and the environment

5.2.1 Safety

- Only operate the product properly, for its intended purpose and within the parameters specified in the technical data. Do not apply any force.
- Only carry out maintenance and repair work on this instrument described in the documentation. Follow the prescribed steps exactly. Use only original spare parts from Testo.

5.2.2 Protecting the environment

- Dispose of faulty rechargeable batteries/spent batteries in accordance with the valid legal specifications.
- At the end of its useful life, send the product to the separate collection for electric and electronic devices (observe local regulations).

5.3 Wall bracket

The wall bracket ensures that the WiFi data logger is kept securely in place.

Mounting materials are not included in the delivery. Select mounting materials that are appropriate for the required mounting location.

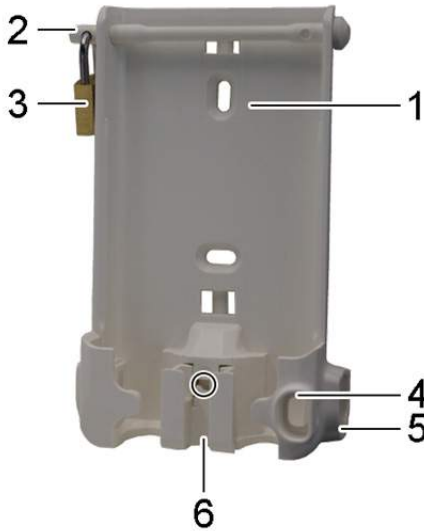

- 1 Wall bracket with notches for mounting materials (screws or cable ties)
- 2 Safety bolt
- 3 Lock
- 4 Storage compartment for USB port sealing plug
- 5 Storage compartment for probe socket sealing plug (left/right)
- 6 USB cable holder, folding: push down on the spot marked with a circle using a screwdriver and slide cable holder downwards.













5.4 Display and control elements

5.4.1 Overview



- 1 Display
- 2 Alarm LED, flashes red in the event of an alarm
- 3 QR code, for direct access to the instrument data in the Testo Cloud
- 4 Control key, to manually start data transfer
- 5 Battery compartment (on rear)
- 6 USB and probe sockets (on the bottom, instrument-specific)

5.4.2 Display icons

Icon	Description
	Battery capacity 75% to 100%
	Battery capacity 50% to 74%
	Battery capacity 25% to 49%
	Battery capacity 5% to 24%, icon flashes: battery capacity < 5%
	External power supply (via USB port)
	WLAN signal strength 100%
	WLAN signal strength 75%
	WLAN signal strength 50%
	WLAN signal strength 25%
	Data connection to the Testo Cloud exists, icon flashes: Data connection to the Testo Cloud being established
	Alarm message
1	Measurement channel 1
2	Measurement channel 2
	Alarm status: upper limit value exceeded
	Alarm status: lower limit value undershot

6 User interface

The screenshot shows the testo Saveris 2 user interface. At the top, there is a dark header bar with the logo and 'testo Saveris 2' on the left, and 'System status' with a red alarm bell icon (callout 1) and 'Account Owner' on the right. Below this is a navigation bar with 'Dashboard' (orange), 'Analysis & reports -', 'Alarms -', and 'Configuration -' (callout 4). The main content area is divided into two sections: 'Measuring points' (callout 5) and 'Active alarms'. The 'Measuring points' section contains a table with columns for Status, Measuring point, Measuring point group, Last value, and Last measurement. It shows two entries: H2_45800848 (Office_2) with a red alarm bell icon and H1_45801022 (Office_1) with a green checkmark icon. Below the table is a 'WiFi data logger details' section for H2_45800848, showing WiFi signal strength, battery level (100%), external power supply, and serial number (45800848). The 'Active alarms' section shows a red warning triangle icon and details for an 'Alarm: Overshooting (24.9°C > 24.5°C) H2_45800848 / Office_2'. At the bottom, there is a footer with copyright information, imprint, AGB, third party libraries, database information (FFM, Germany Test, Server: Europe FFT 01), and revision information (10237, Location: final).

- 1 System and status information (see page 36)
- 2 Command bar (see page 36)
- 3 User management (see page 35)
- 4 Menu bar with the main menus:

Dashboard (see page 25)

- Analysis & reports (see page 25)
- Alarms (see page 27)
- Configuration (see page 30)

5 Display area

7 Dashboard

The dashboard is the home page. It provides an overview of the key system data: **Measuring points** and **Active alarms**.

7.1 Measuring points

A summary of all measuring points is displayed.

Click on the icon ▶ to display more information.

7.2 Active alarms

A summary of all active alarms and system warnings is displayed. Unread alarms and system warnings are shown in **bold**.

Click on the icon ▶ to display more information.

On displaying the detailed information, the alarm message/system warning is marked as "read" and the alarm counter is marked down.

8 Analysis & reports

8.1 Data analysis

Displaying and analyzing readings and alarms

The display can be filtered according to the following characteristics:

- By measuring point group/measuring point: click on the checkbox in front of the measuring point group/measuring point.
- By date/time: click on the start date/end date and select the start date/start time and end date/end time.
- By time range: click on the required time range, for example **Last hour**.

Readings can be displayed in a table or as a graphic.

- Click on the **Table** or **Graphic** button to select the required view.
- In the Graphic data view, other analysis functions are available. See Online Help.

Alarms can be presented as a table.

- Click on the **Alarms** button to display the alarms.
- Click on the icon ▶ to display more information.

Exporting readings and alarms (manually create a report)

1. Filter the display so that the measuring points and time periods that you want to appear in the report are displayed.
2. Click on the **Export** button and select the required output format (**PDF** or **CSV**).
3. Enter the data required to create the report and click on the **Generate and download** button.

Creating an automatic report

Automatic reports are regularly generated automatically by the system, according to the settings specified by the user.

1. Click on the **Create an automatic report** button.
2. Enter the data required to create the automatic report and click on the **Create an automatic report** button.

See also Automatic reports, page **26**.

8.2 Automatic reports

Automatic reports are regularly generated automatically by the system (Generated reports), according to the settings specified by the user (Report settings).

Creating an automatic report

1. Click on the **Create an automatic report** button.
2. Enter the data required for creating the automatic report.

The following settings can be defined and edited:

- **Name of the report:** designation of the automatic report.
- **Measuring points for the report:** measuring points that are to be covered in the report. Click on the checkbox in front of the channel designation.
- **How often is the report to be created?:** interval at which the reports are to be generated. Select a report cycle from the drop-down menu.
- **File format:** file format in which the reports are to be generated. Select a file format from the drop-down menu.
- **Data views:** data views in which the data in the reports is to be displayed. Click on the checkbox in front of the data view designation.

- **Also send report via e-mail:** as well as saving reports under **Generated reports**, these can also be sent as e-mails. Click on the checkbox to open the input screen for e-mail addresses.
3. Click on the **Create an automatic report** button.
The first report will be created on the following day.

Generated reports

A summary of the reports already generated is displayed.

Click on the icon ► to display more information.

- Click on the **Download** button to download a report.
- Click on the **Edit this report series** button to display and edit the settings.

Report settings

Automatic reports which have already been created are displayed in a table.

- Click on the **Actions** button and then on **Edit** to display and edit the settings.
- Click on the **Actions** button and then on **Delete** to delete the automatic report.

9 Alarms

9.1 Alarm list

Display of alarms

A summary of all triggered alarms and system warnings is displayed. Unread alarms and system warnings are shown in **bold**.

The display can be filtered according to the following characteristics:

- By measuring point group/measuring point: click on the checkbox in front of the measuring point group/measuring point.
- By date/time: click on the start date/end date and select the start date/start time and end date/end time.

Detailed information on alarms

Click on the icon ► to display more information.

On displaying the detailed information, the alarm message/system warning is marked as "read" and the alarm counter is marked down.

Click on the **Mark all as read** button to mark all alerts as "read".

9.2 Alarm settings

Creating and displaying alarm settings

- Click on the **+ New alarm setting** button to create a new alarm setting.

Existing alarm settings are displayed below the button.

- Click on the title of an alarm setting to display it.

Configuring and editing a displayed alarm setting

The following settings can be defined and edited:

- **Title:** designation of the alarm setting (required field).
- **Measuring points:** Measuring point group/measuring point which is to be monitored. Click on the checkbox in front of the measuring point group/measuring point.
- **Alarm limit value 1 and 2:** Different limit value ranges which can be defined for different periods.
- **Upper limit, lower limit:** Are values which are to be monitored.
- **Alarm delay:** Minimum duration of a limit value violation before an alarm is triggered.



The time intervals between measurements (measurement rate) should be smaller than the alarm delay (e.g. measurement rate = 5 minutes, alarm delay = 15 minutes).

- **Timed control:** Define individual alarm periods for which the alarm limit values 1 and 2, or no alarm at all, apply. To define the alarm value 1 and 2, double-click on a time point in the table or pull open the desired time period with the mouse. In periods in which the table is left empty, you receive no alarm.



If you have not defined alarm periods, the alarm limits will be active 24 hours a day.

If alarm periods have been defined, the limit value alarms are active only in the marked period.

- **Channel alarms:** alarms in the event of a defective sensor.

- **E-mail recipient:** addressees who are informed when an alarm occurs. Click on the checkbox in front of the recipient or enter the name and e-mail address of other recipients and click on the **+ Add** button.
- **SMS recipient:** addressees who are informed when an alarm occurs. Click on the checkbox in front of the recipient or enter the name and mobile phone number of other recipients and click on the **+ Add** button.
- **Save:** click on the button to save the settings.
- **Delete:** click on the button to delete the alarm setting.

9.3 System warnings

Creating and displaying system warnings

- Click on the **+ New system warning** button to create a new system warning.

Existing system warnings are displayed below the button.

- Click on the title of a system warning to display it.

Configuring and editing a displayed system warning

The following settings can be defined and edited:

- **Title:** designation of the system warning (required field).
- **Battery almost discharged:** monitor the WiFi data logger for discharged battery.
- **Power supply interrupted:** monitor the external power supply of the WiFi data logger for interruptions.
- **WiFi data logger is not responding:** monitor the WiFi data logger for data transmission failure. Click on the **Activate** button and configure the monitoring cycle using the slide control.



Note

The set time should be greater than the WiFi data logger's communication cycle.

- **WiFi data logger:** measuring point group/measuring point which is to be monitored. Click on the checkbox in front of the measuring point group/measuring point.
- **E-mail recipient:** addressees who are informed when an alarm occurs. Click on the checkbox in front of the recipient

or enter the name and e-mail address of other recipients and click on the **+ Add** button.

- **SMS recipient:** addressees who are informed when an alarm occurs. Click on the checkbox in front of the recipient or enter the name and mobile phone number of other recipients and click on the **+ Add** button.
- **Save:** click on the button to save the settings.
- **Delete:** click on the button to delete the system warning.

10 Configuration

10.1 Users

Users can be created and managed.

Standard users

By default, two users are created in the system:

- Account Owner (name can be changed), with Administrator user role (role cannot be changed).
- Testo Support (name can be changed), with Testo User Support user role (role cannot be changed).

Creating and editing new users

Other users with different User roles (see page 31) can be created and edited.

- Click on the **Add a new user** button to create a new user.

Existing users are displayed in a list.

- Click on the name of a user to display the settings.
- Click on the **Edit** button to change the settings.

The following settings can be defined and edited:

- **Title:** title of the user.
- **First name:** first name of the user (required field).
- **Second name:** second name of the user.
- **Surname:** surname of the user (required field).
- **Password** and **Repeat password:** user password. The user password, can be changed by the user at a later stage.
- **User role:** defines the user permissions within the system.

- **E-mail address & login:** e-mail address of the user. The e-mail address is also the login name. The e-mail address is also used for system notifications (alarms, system warnings).
- **Change e-mail address & login** (field is only available when editing the user account of the account holder): Enter a new e-mail address. Entering a new e-mail address also changes the login name.
- **Mobile number:** telephone number of the user, this is used for system notifications (alarms and system warnings).
- **Active from:** date from which the user is active.
- **Active to:** date up to which the user is active.
- **Details:** text field for entering other user-specific information.
- **Save:** click on the button to save the settings.

10.2 User roles

A description of the available user roles can be displayed.

- Click on the title of a user role to display a description of it.
- Users have different permissions depending on their allocated user role:

Permissions	Administrator	Analyst	Auditor	Operator
Display created users	x	x	x	x
Create, edit and delete users	x	-	-	-
Display Account ID	x	-	-	x
Login WiFi data loggers	x	-	-	x
Configure and deactivate WiFi data loggers	x	-	-	x
Create, edit and delete areas	x	-	-	x

Permissions	Administrator	Analyst	Auditor	Operator
Display, create, edit and delete alarm settings and system warnings	x	-	-	x
Read and analyze readings	x	x	x	x
Display details about alarms and system warnings (= mark alarms and system warnings as read)	x	x	x	x
Create automatic reports	x	-	-	x

x = available, - = not available

10.3 Account ID

The Account ID is the unique address of your user account in the Testo Cloud. This is needed to configure the WiFi data loggers in order to ensure that they send your data to the correct user account.

10.4 Measuring point groups

Measuring points can be organized into measuring point groups.

Assigning measuring points to a measuring point group (e.g. Room 1, Room 2, etc.) makes the administration of multiple measuring points easier.

See also Areas, page 33.



Creating and editing a measuring point group

- Click on the **New measuring point group** button to create a new measuring point group.

Measuring point groups already created are displayed in a list.

- Click on the **Actions** button and then on **Edit** to display and edit the settings.

The following settings can be defined and edited:

- **Title:** designation of the measuring point group (required field).
- **Description:** description of the measuring point group.
- **Area:** area that the measuring point group is to be assigned to.
- **Measuring points:** available measuring points and those assigned to the measuring point group are displayed. Click on the icon  to assign a measuring point to the group. Click on the icon  to delete a measuring point from the group.
- **Save:** click on the button to save the settings.
- **Delete:** click on the button to delete the measuring point group.

Deleting a measuring point group

- Click on the **Actions** button and then on **Delete** to delete the measuring point group.

10.5 Areas

Measuring point groups can be organized into areas.

See also Measuring point groups, page 32.

Creating and editing an area

- Click on the **New area** button to create a new area.
- Areas already created are displayed in a list.
- Click on the **Actions** button and then on **Edit** to display and edit the settings.

The following settings can be defined and edited:

- **Display name:** designation of the area (required field).
- **Description:** description of the area.
- **Save:** click on the button to save the settings.
- **Delete:** click on the button to delete the area.

Deleting an area

- Click on the **Actions** button and then on **Delete** to delete the area.

10.6 WiFi data loggers

A summary of all WiFi data loggers logged on is displayed.

- Click on the **Details** button to display more information.
- Click on the **Deactivate** or **Activate** button to deactivate or activate WiFi data loggers.

Configuring a WiFi data logger

- Click on the **Configure** button to change the configuration.

The following settings can be defined and edited:

- **Name of the WiFi data logger:** designation of the WiFi data logger (required field). Condition at delivery: **Model_Serial number**
- **Description:** description of the WiFi data logger.
- **Select battery type:** set the battery type used. For the battery capacity to be displayed correctly, the correct battery type must be selected.
- **Display:** switch the display of the WiFi data logger on or off.
- **Name of the measuring point:** designation of the measuring point (required field).
- **Measuring cycle:** interval at which readings are obtained. Set the measuring cycle using the slide control.
- **Day communication cycle** and **Night communication cycle:** interval at which readings are transmitted to the Testo Cloud. Select the start time for the day communication cycle and the night communication cycle. Set the communication cycle using the slide control.
- **Channel name:** designation of the measurement channel (required field). Condition at delivery: **Model_Serial number_Channel number**
- **Select unit:** unit in which the readings are displayed.
- **Select sensor type** (only for model T2, T3): sensor type used by the measurement channel.
- **Save:** click on the button to save the settings.
- **Deactivate** or **Activate:** click on the button in order to deactivate or activate measurement channels or WiFi data loggers.

- **Remove:** click on the button in order to log WiFi data loggers off the system.

10.7 Firmware updates

A list with available firmware updates for the WiFi data loggers is displayed. Firmware updates can be installed on the data loggers via WiFi.

- Click on the **Activate** button to install a firmware update.

11 User management

The user management provides information and settings options for the user account.

- Click on the icon  to open the **User menu**.

11.1 User settings

User-specific settings can be made.

- **Language:** select the language of the user interface.
- **Time zone:** select the time zone for the date and time display.
- **Save:** click on the button to save the settings.

11.2 Account information

Information about your Saveris 2 account is displayed.

11.3 Change password

The user password can be changed.

New password and **New password (repeat):** enter new password in both text fields.

- **Save:** click on the button to save the settings.

► Note

It is not possible to change the user name (e-mail address).

11.4 Logoff

The user is logged off the system.

- **Logoff:** click on the text to log off.

12 Command bar

12.1 Open Quick Start Guide

The Quick Start Guide can help you with logging in WiFi data loggers.

- Click on the icon  to open the **Quick Start Guide**.

12.2 Open Online Help

The Online Help (this document) provides support for issues related to the product components.

- Click on the icon  to open the **Online Help**.

12.3 Open system messages

The system messages contain important information relating to the product.

- Click on the icon  to open the **System messages**. The number of unread system messages is displayed above the icon.

A summary of all system messages is displayed. Unread system messages are shown in **bold**.

- Click on the title of a system message to display more information.

On displaying the detailed information, the system message is marked as "read" and the message counter is marked down.

13 System and status information

13.1 Display system status

Displays the alarm status.



: no alarms active



: alarms active, number of unread alarms is displayed

- Click on the icon to open the **Alarm list**.

