

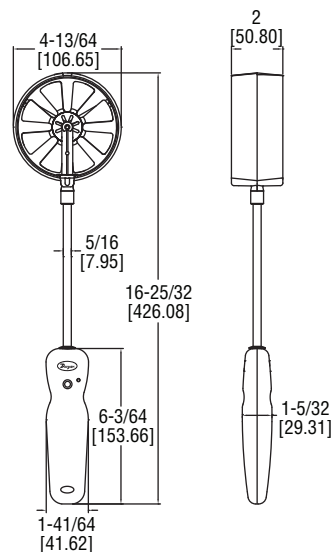

## Model VP2 Wireless 100 mm Vane Thermo-Anemometer Probe for UHH/UHH2

### Specifications - Installation and Operating Instructions



The Model VP2 Wireless 100 mm Vane Thermo-Anemometer Probe measures air velocity, air flow, humidity, and temperature when combined with Models UHH and UHH2 or the Dwyer Mobile Meter app. By having a larger diameter, the rotating vane is able to measure velocities down to 50 fpm or 0.25 m/s. An arrow is molded into the vane housing to depict the flow direction.

Wireless probes can take measurements up to 50 feet away from the base unit. A bicolor LED flashes on the handle of the probe to indicate communication status with the base unit. The battery is rechargeable via the mini-USB connector on the bottom of the probe.

#### NOTICE

This device complies with Industry Canada license-exempt RSS standard(s). Operation is subject to the following two conditions:

(1) This device may not cause harmful interference, and (2) this device must accept any interference received, including interference that may cause undesired operation.

Cet appareil est conforme à des règlements d'Industrie Canada exempts de licence standard RSS (s). Son fonctionnement est soumis aux deux conditions suivantes: (1) Ce dispositif ne doit pas causer d'interférences nuisibles, et (2) cet appareil doit accepter toute interférence reçue, y compris les interférences pouvant entraîner un fonctionnement indésirable.

This Class B digital apparatus complies with Canadian ICES-003.

Cet appareil numéroté de la classe B est conforme à la norme NMB-003 du Canada.

#### CHARGING BATTERY

#### NOTICE

It is required prior to the initial usage to charge the battery for 12 hours.

When the charge of the battery is almost used up, the LED on the handle of the wireless probe will turn solid red. There is approximately 5 minutes of battery life left at this point. If the probe is not already paired to the UHH, it will not pair while in low battery condition.

- Step 1: Open the USB cover on the bottom of the probe handle.
- Step 2: Plug the mini-USB connector end of the cable into the probe handle.
- Step 3: Plug the USB connector end of the cable into the port on the charger or PC.
- Step 4: Plug the charger into either an electrical outlet or car charging port (LED on the charger and the handle should both light up).
- Step 5: The LED on the handle will turn off when fully charged.
- Step 6: Remove charger from electrical outlet.
- Step 7: Remove USB connectors from the handle and the charger.
- Step 8: Replace the USB cover on the bottom of the probe handle.

#### SPECIFICATIONS

**Service:** Clean air.

**Temperature Limits:** Process: -4 to 140°F (-20 to 60°C); Ambient: 5 to 125°F (-15 to 51°C).

**Range:** Air Velocity: 50 to 5000 fpm (0.25 to 25 m/s); Temperature: -22 to 140°F (-30 to 60°C); Relative Humidity: 0 to 100% RH; Air Volume: 999,999 in selected units.

**Accuracy:** Air Velocity: 0.25 to 10 m/s: ±1.5% of reading ±20 fpm (±0.1 m/s); 10 to 20 m/s: 1.5% of reading ±40 fpm (±0.2 m/s); 20 to 25 m/s: ±1.5% of reading ±60 fpm (±0.3 m/s); Temperature: ±0.54°F @ 77°F (±0.3°C @ 25°C); Relative Humidity: ±2% @ 77°F (25°C) (10 to 90% RH); ±4% (0 to 10% and 90 to 100%).

**Response Time:** Air Velocity: 1 s; Temperature: 1.5 s; Relative Humidity: 1.5 s; Air Volume: 1 s.

**Probe Length:** 8" (203 mm) insertion.

**Power Requirements:** 3.7 V YT562447 lithium ion battery, installed functional, user replaceable.

**Battery Charging Limits:** 32 to 113°F (0 to 45°C).

**Maximum Wireless Distance:** 50' (15 m).

**Vane Material:** Anodized aluminum.

**Handle Enclosure:** Thermoplastic elastomer over polycarbonate.

**Supplied With:** Wrist strap.

**Weight:** 13.6 oz (402.20 g).

#### WARNING







Lithium ion polymer batteries are very volatile and can cause a fire if punctured or severely damaged. Only use a Dwyer Instruments, Inc. approved charging device in a well ventilated area away from any flammable materials or gases. Do not incinerate the battery. Only charge between 32 to 113°F (0 to 45°C).

#### NOTICE

If desired, can be operated with USB cables less than 3 m in length when connected to the charger or PC.



## USING WITH UHH

### Pairing with Wireless Probes

1. Turn on Model UHH Universal Handheld by pressing the  button.
2. Press the  and  buttons to scroll through the menu headings at the top of the display.
3. When **PROBE** is highlighted, hit the  button to access the probe menu.
4. Press the  directional arrow to scroll through the sub-menu headings. The current selected parameter will be highlighted in yellow.
5. When **PAIRING MODE** is highlighted, hit the  button to access the pairing mode.
6. Turn on the wireless probe(s) to be paired. After a period of up to 15 to 20 seconds, the UHH screen will update with the information about the wireless probe(s) just turned on.

#### NOTICE

If a probe does not appear, power the probe down, then power it back on.

7. Press the  button to scroll through the available probes. The current selected probe will be highlighted in yellow.
8. When the desired probe to be paired is highlighted, hit the  button to pair the probe. Once it is paired, it will be removed from the list automatically.
9. Once all the desired probes are paired, press  button.
10. Repeat step 9 to go back to the home screen and begin readings.

## USING WITH UHH2 OR MOBILE METER® APP

### Pairing with Wireless Probes

For the latest instructions, please refer to the "Help" button in the Options menu in the Mobile Meter® app.

1. Verify that the UHH2 or handheld device has Bluetooth® technology turned on and is connected to the wireless gateway. Open the Mobile Meter® app by clicking on the icon.
2. Press "Get Started".
3. Near the bottom, a pop-up will display a message that reads "Bluetooth is searching for bridges...". When a bridge is turned on and discovered by Mobile Meter® the pop-up will display "Mobile Meter has CONNECTED to the Bluetooth device: PROBEBRIDGE\_XXXXXX" where XXXXXX is the probe's serial number.
4. Click on the Options menu and select "Setup".
5. In the Setup page, probes can be discovered and paired to the Mobile Meter® app. After the Mobile Meter® app connects to a bridge, a probe can be discovered. To discover a probe, simply turn on the probe by pressing the button on the handle and it will show up in the Setup list.
6. Use the back button or navigation arrow to go back to the Probes List page.

#### NOTICE

It is recommended that only four probes be selected due to the bandwidth limitations between the UHH2/Mobile Meter® app and the gateway.

## ACCESSORIES

To maximize the usefulness of the VP2, an optional cone kit (A-VPX-CKIT) is available. A round 7.2 in (183 mm) diameter hood and a rectangular 10.9 x 8.9 in (277 x 226 mm) hood are included in the kit. The cones are able to convert the VP2 into an air volume flow balancing tool for use with small grilles and diffusers.



## WIRELESS GUIDELINES IN ACCORDANCE WITH FCC:

Changes not expressly approved by Dwyer Instruments, Inc. could void the user's authority to operate the equipment.

This product complies with FCC OET Bulletin 65 radiation exposure limits set forth for an uncontrolled environment.

Pursuant to FCC 15.21 of the FCC rules, changes not expressly approved by Dwyer Instruments, Inc. might cause harmful interference and void the FCC authorization to operate this product.

### Canadian Government Guidelines:

Operation is subject to the following two conditions: (1) This device may not cause harmful interference and (2) this device must accept any interference received, including interference that may cause undesired operation.

## INFORMATION TO THE USER

Power Output: 6 mW

Operating Frequency: 2.4 GHz

Operating Channel: 11

Operating Mode: IEEE 802.15.4, Zigbee, Direct Sequence Spread Spectrum

Data Rate: Up to 250 kbps

Intended Use: Industrial/commercial HVAC

Antenna Connection: Internal only, non-tunable

### Battery Removal:

If, for some reason, the wireless probe needs to be returned to Dwyer Instruments, Inc. for maintenance or repair, the rechargeable lithium ion battery needs to be removed prior to shipping the unit. Before attempting to remove the battery ensure the probe has been powered down. To remove the battery, set the wireless probe face down on a non-abrasive surface. There are four Phillips head screws that secure the two halves of the handle together. Two are located under the serial number label at the top of the probe and two are located at the bottom of the unit. When lifting the ends of the serial label to access the screws be careful to not damage the label such that the serial number cannot be read. Remove the four screws with a suitable Phillips screw driver and set aside the back half of the housing. Remove the battery by grasping the black plastic connector on the battery wire harness and pull straight out while securing the black plastic connector on the circuit board with the other hand. Be careful to not puncture the battery as this may cause a fire. Remove the battery and set aside. Securely replace the four screws to hold the handle of the probe together. The unit may now be packaged for shipping back to Dwyer Instruments, Inc.

### MAINTENANCE/REPAIR

Upon final installation of the Model VP2, no routine maintenance is required. The Model VP2 is not field serviceable and should be returned if repair is needed. Field repair should not be attempted and may void warranty.

### WARRANTY/RETURN

Refer to "Terms and Conditions of Sales" in our catalog and on our website. Contact customer service to receive a Return Goods Authorization number before shipping the product back for repair. Be sure to include a brief description of the problem, plus any additional application notes.

Bluetooth® is a registered trademark of Bluetooth SIG, Inc.