

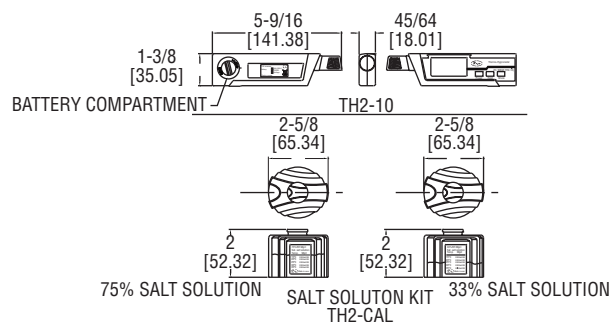

## Series TH2-10 Thermo-Hygrometer Pen

### Specifications - Installation and Operating Instructions



The Model TH2-10 Thermo-Hygrometer Pen is a compact handheld device that measures temperature, humidity, dew point, wet bulb, and heat index. For increased accuracy, calibration salt baths can be used to field calibrate the humidity sensor before taking measurements. Minimum, maximum, and average readings can be displayed on the large 4 digit LCD display. High and Low alarms provide audible and visual indication of changes to the ambient humidity.

#### FEATURES

- 1) Temperature and relative humidity measurement.
- 2) Calculate dew point temperature and wet bulb temperature.
- 3) Calculate heat index and wet bulb global temperature.
- 4) Hi Temperature alarm setting (Heat Index/WBGT).
- 5) Data hold & Maximum/Minimum/Average function.
- 6) Auto power off function.
- 7) Self-calibration by salt bottle (Optional) at 33% & 75% humidity points.
- 8) Quick response and high accuracy.

#### OPERATING INSTRUCTIONS

Please read the manual completely before using this device.

#### KEY FUNCTION

- (1) **PWR**: Turn on / off the meter.
- (2) **HOLD**: Data hold mode.
- (3) **MODE**: Select measurement modes: Temp. (temperature), RH (Relative Humidity), HI (heat index), DP (dew point), WB (wet bulb), HI WB (wet bulb global temperature / WBGT).

#### OPERATION

##### Power On/Off

Press the **POWER** button to turn on the meter. The meter will display TEMP reading and icon with a beep sound. To turn off the meter, press the **POWER** button for more than 2 seconds.

##### Maximum and Minimum Mode

With the meter already on, press the **POWER** button less than 2 seconds. The MAX icon with the highest reading appears on the LCD. Press the **POWER** button

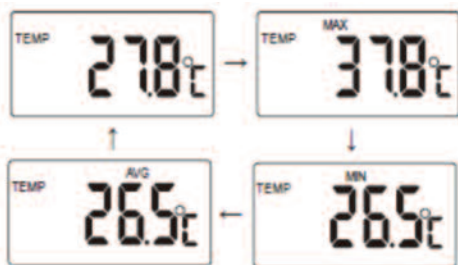

again and the MIN icon will appear with the lowest reading on the LCD. Press the **POWER** button again and the AVG icon appears with the average reading on the LCD. Press **POWER** again and the meter will return to normal measurement.

#### SPECIFICATIONS

**Range:** RH: 0 to 99.99%; Temperature: -4 to 122°F (-20 to 50°C).

**Accuracy:** ±3% @ 25°C/10 to 90% RH (±5% @ 0 to 10%, 90 to 100%) ±1°F (0.6°C).

**Display:** 4-digit LCD.

**Resolution:** 0.1°F/°C.

**Power Requirements:** One CR-2032 lithium battery.

**Weight:** 3.2 oz (91 g).

**Agency Approvals:** CE.

#### DATA HOLD

Press the **HOLD** button to freeze readings. Press the **HOLD** button again to return to normal measurement.

#### Auto Power Off

The meter will shut off automatically after approximately 15 minutes of no action. To disable auto power off, press the **HOLD** and **POWER** button at the same time until "S-no" appears. Then release the button and you will return to normal measurement.

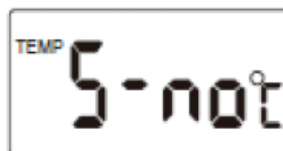

Once the meter is powered off, it will return to the default auto power off settings.

#### SELECT TEMP UNIT °C/°F

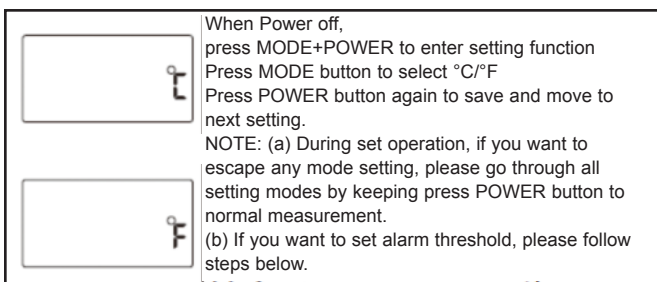

#### SETTING MODE- ALARM SETTING (AFTER SELECTING TEMP UNIT °C/°F)



##### Note:

1. The alarm sound can't be disabled unless you enter setting mode to change the threshold setting.
2. The default settings of Heat Index and WBGT alarm settings are off.
3. Please go through and select Temp. unit (C/F) before alarm setting.

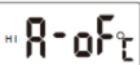
Step 1. Heat Index Hi alarm select

	Press MODE to select HI (Heat Index) alarm ON or OFF.
	(a) When alarm function is on, press POWER button to enter Heat Index setting (move to Step 2). (b) When alarm function is off, press POWER button to enter WBGT (HI WB) alarm setting (step 3).

Step 2. Heat Index Hi Temp. setting.

	When Hi alarm is on, HI (Heat Index) icon with the default value 27.8°C (82°F) appears on the LCD. Keep pressing MODE button to increase digit sequentially from hundred digit and release the button when the digit up desired appears.
	(Please refer to Example 1). Press POWER button to save HI setting and go to WBGT alarm selecting.

Step 3. WBGT alarm select

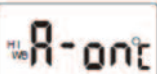
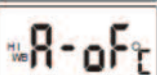
	Press MODE to select HI WB (WBGT) alarm ON/OFF.
	(a) When the alarm function is on, press POWER button to enter WBGT setting (move to Step 4). (b) When the alarm function is off, press POWER button to go back to normal measurement.

Step 4. WBGT Hi Temp. setting

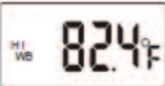
	When WBGT alarm is on, HI WB (WBGT) icon with the default value 28.0°C (82.4°F) appears on the LCD. Keep pressing MODE button to increase digit sequentially from hundred digit and release the button when the digit you desired appears. (Please refer to Example 1). Press POWER button to save WBGT setting and the meter will go to normal measurement.
	

Note:

**HEAT INDEX:** The Heat Index is determined using the dry bulb temperature and relative humidity. It is based upon charts available from the U.S. National Weather Service. The Heat Index represents how an average person feels relative to climate conditions. For a given temperature, the higher the humidity, the higher the heat index will be.

TROUBLE SHOOTING

Error messages:

E-2	Humidity sensor is failed.
E-3	Temperature sensor is failed.
E-4	Operation temperature is too high.
E-5	Operation temperature is too low.
E-6	Some hardware has failed.

Note: If above error messages appear on the display, please contact with local distributor for technical service.

BATTERY REPLACEMENT

When low battery indication "BAT" icon appears on the LCD, the battery needs to be replaced.



Use a coin to remove the battery compartment cover on the rear of the meter. Replace the CR-2032 lithium battery with a new battery face up (+) in the compartment.

# Example 1 - Set Hi Temp. Alarm at 128.3°C



Step 1:

Keep pressing the MODE button, the numbers will cycle from 0 to 9. It will jump to the next digit to the right when the desired number (0 to 9) is reached. So for this example, we need a "1" in the thousand unit column. When the number desired is reached, it will jump to the next digit to the right.

Step 2:

Keep pressing the MODE button, the same action as before until the hundreds digit shows "2". Then release the MODE button.

Step 3:

Keep pressing the MODE button, the same action as before until the tens digit shows "8". Then release the MODE button.

Step 4:

Keep pressing the MODE button, the same action as before until the last unit digit shows "3". Then release the MODE button.

MAINTENANCE/REPAIR

Upon final installation of the Series TH2-10, no routine maintenance is required. The Series TH2-10 is not field serviceable and should be returned if repair is needed. Field repair should not be attempted and may void warranty.

WARRANTY/RETURN

Refer to "Terms and Conditions of Sales" in our catalog and on our website. Contact customer service to receive a Return Goods Authorization number before shipping the product back for repair. Be sure to include a brief description of the problem plus any additional application notes.