

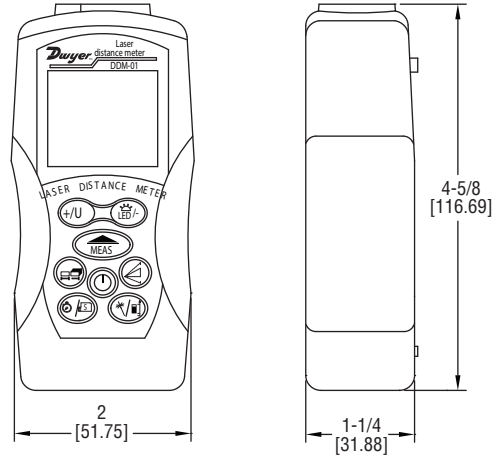

Model DDM-01 Laser Distance Meter

Specifications - Installation and Operating Instructions



The Model DDM-01 Laser Distance Meter offers quick measurement of distances up to 229.7 feet (70 meters) with the click of a button. It is also able to easily make area and space calculations and volume measurements from what it records. Another feature of the Model DDM-01 is that it is able to use the Pythagorean Theorem to indirectly calculate the height of an object. The meter can read out in feet, inches, or meters and includes a backlight for use in dark areas.

PRODUCT OVERVIEW

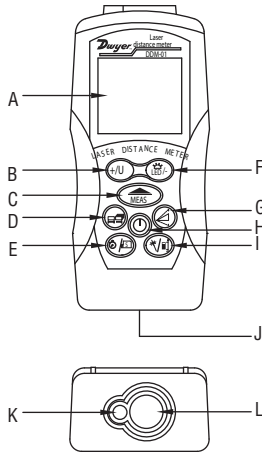

Figure 1

- | | |
|---|-----------------------------------|
| A. LCD | G. Pythagorean I, II, & III |
| B. Add/Unit Switch | H. Power Button/Clear |
| C. Measure/Continuous Measure | I. Reference Switch/Laser Pointer |
| D. Measuring Function
(Area, Dimension, Stake Out) | J. Battery Cover |
| E. Timer/Memory | K. Laser Emitting Window |
| F. Subtract/Backlight | L. Receiving Window |

NOTICE If there are two settings separated by a "/" for one button, the setting that is listed before the slash will be activated when the button is pressed once. If it is listed after the slash, then it will be activated when the button is pressed and held.

SPECIFICATIONS

- Range:** 0.16 to 229.7 feet (0.05 to 70 m).
- Accuracy:** ±0.005 feet (±1.5 mm).
- Display:** Three line LCD (top two with 4 digits/bottom with 5 digits).
- Resolution:** 0.001 feet (0.001 m).
- Response Time:** 0.5 s.
- Laser Type:** 650 nm, class 2, <1 mW.
- Beam Size:** 25 mm at 30 m.
- Temperature Limits:**
 - Operating: 23 to 104°F (-5 to 40°C);
 - Storage: -4 to 140°F (-20 to 60°C).
- Power Requirements:** (2) 1.5 V AA carbon zinc batteries, included, user replaceable.
- Weight:** 21.6 oz (612.35 g).
- Agency Approvals:** CE, RoHS.

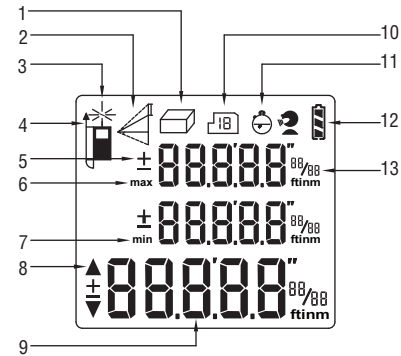

Figure 2

- | | |
|--|-------------------------------|
| 1. Measuring Function Area
Measuring Volume Measuring | 7. Minimum Distance |
| 2. Indirect Measuring Single Height
Sum of Two Heights
Difference of Two Heights | 8. Stakes Direction Indicator |
| 3. Laser Indicator | 9. Main Display & Units |
| 4. Measuring Reference | 10. Memory |
| 5. Add and Subtract | 11. Countdown Measuring |
| 6. Maximum Distance | 12. Battery Status |
| | 13. Sub-Display & Units |

POWERING ON

NOTICE

Before turning on the meter, make sure the batteries are installed properly. To install or change batteries, remove the back battery cover, remove any batteries that are already installed, install the new batteries being sure to observe correct polarity, and replace the lid.

To power on the meter, press the power button once. The initial screen will flash for a few seconds to check the meter, and after checking, the meter will display the standby screen.

CAUTION

Laser will be emitted upon starting the meter. Do not look into the beam. Permanent eye damage may occur.

MEASURING DISTANCE

Check the icon in the upper left corner of the display to see if the laser is emitted. See Figure 3.

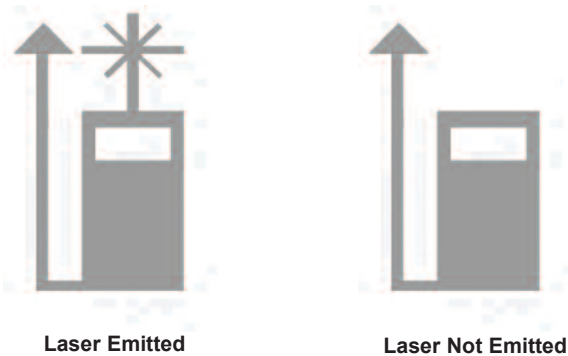

If the laser is not activated, press the measure button to enable the laser. Move the laser point onto the target, then press the measure button to take measurement. Keep the dot on the target until a beep is heard, notifying that the measuring is complete. The distance will then be shown on the main display and the laser will be turned off.

Changing Unit of Measure

The default unit of measurement is meter. To change the unit of measurement, press and hold the unit switch button. The unit will be switched by each press. Repeat until the required unit is displayed in the bottom right corner. The available units are:

- Meters (m)
- Feet (ft)
- Inches (in)
- Feet and inches (ft & in, with tick marks also shown by numbers)

Changing Reference Point

The default reference point is set to the rear of the meter. To change the reference point for measuring, press the reference switch button. The available reference points are at the front of the meter and at the rear.

ADDING/SUBTRACTING MEASUREMENTS

Once the first distance is found, press the add or subtract button once. Then find the next distance to be added or subtracted from the first distance and press the add or subtract button again. The result will be shown on the main display.

CONTINUOUS MEASURING

To activate the continuous measuring setting, hold down the measure button. The laser will turn on when continuous measuring is activated. In this setting, the meter will take continuous measurements, showing the most recent measurement on the main display, and the maximum and minimum measurements shown on each of their respective sub-displays. To pause continuous measuring, press the measure button. To quit and go back to the normal measuring mode, press the power button.

STAKE OUT FUNCTION

The meter includes a stake out function, which allows the user to set a specific distance needed, and the meter will notify the user when that distance is reached during the continuous measuring setting. To set the stake out distance, press the measuring function button three times. Then, press the add or subtract button to increase or decrease the value. Press the measure button to shift between the whole number and decimal number. Press the power button to return to zero. When the value is decided, press the measuring function button to finish.

To measure with the set stake out point, activate continuous measuring. As it measures, the meter will show arrows of whether the meter needs to move closer to or farther from the object to reach the specified distance. It will beep repeatedly when the set distance is reached. See Figure 4.

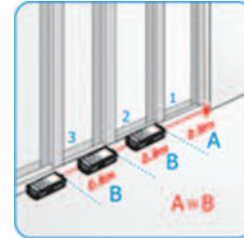

Figure 4

SETTING THE MEASUREMENT TIMER

There is a timer available in the meter to allow for a more stable measurement, which can be set from 3 to 15 seconds. To set the timer, press the timer button until the desired time is shown at the top of the screen. After the time is set, point the meter at the target and press the measure button. The meter will beep when the measurement has been taken and the result will be shown on the main display.

MEASURING AREA

To measure the area of a space, press the measuring function button once to enable area measuring. The laser will be turned on upon beginning area measuring. The measuring function icon on the display will blink to show which measurement needs to be taken at each time. Measure the distance of the length and width of the space as stated in "Measuring Distance." Once all distances have been measured, the area is shown on the main display. See Figure 5.

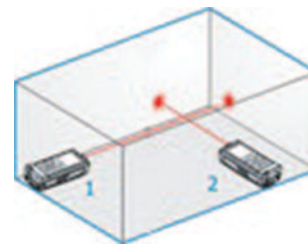

Figure 5

MEASURING VOLUME

To measure the volume of a space, press the measuring function button twice to enable volume measuring. The laser will be turned on upon beginning volume measuring. The measuring function icon on the display will blink to show which measurement needs to be taken at each time. Measure the distance of the length, width, and height of the space as stated in "Measuring Distance." Once all distances have been measured, the volume is shown on the main display. See Figure 6.

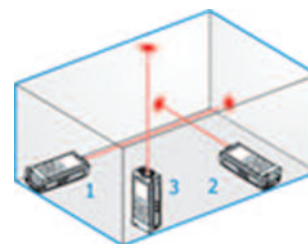

Figure 6

MEASURING HEIGHT (INDIRECT)

To measure the height of an object indirectly, press the Pythagorean button once to enable Pythagorean I (Single Height), twice to enable Pythagorean II (Addition of Two Heights), and three times to enable Pythagorean III (Subtraction of Two Heights). This setting uses the Pythagorean theorem to find the distance between two points using a variation of methods. For all methods, the indirect measuring icon on the display will blink with which measurement needs to be taken at each time.

Single Height

This setting is used to find a distance between two points using one height. See Figure 7 below for further clarification. First, take the measurement at the top distance (1). Then, take the distance at the horizontal (2). The meter will then show the distance between points 1 and 2 on the main display.



Figure 7

Addition of Two Heights

This setting is used to find the distance between two points using the addition of two heights. See Figure 8 below for further clarification. First, take the measurement at the top height (1). Then, take the horizontal measurement in between the two heights (2). Last, take the measurement at the bottom point (3). The meter will then show the distance between points 1 and 3 on the main display.

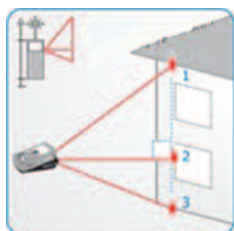

Figure 8

Subtraction of Two Heights

This setting is used to find the distance between two points using the subtraction of two heights. See Figure 9 below for further clarification. First, take the measurement at the top height (1). Then, take the measurement at the second height (2). Last, take the measurement at the horizontal (3). The meter will then show the distance between points 1 and 2 on the main display.

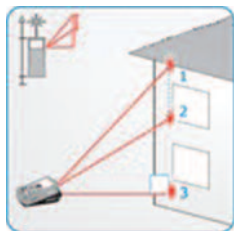

Figure 9

MEASURING IN BRIGHT AREAS

The working range and accuracy of the meter depend on how well the energy of the laser is reflected from the surface of the target back to the receiving window of the meter. When using the distance meter in bright ambient areas, it may help to use a white target to increase the working range and the stability of accuracy.

MEMORY RECALL

The meter includes a memory recall function that stores the last 20 measurements. To look up the records, press and hold the memory button until the memory is shown on the display. Press the add button to move up the list, and the subtract button to move down the list.

BACKLIGHT

To turn the backlight on and off, press and hold the backlight button.

LASER POINTER

To turn the laser pointer on and off, press and hold the laser pointer button. This will cause the laser icon to display on the screen.

ERROR CODES

Occasionally, the meter will display that an error has occurred. Refer to Table 1 below if an error message is shown on the meter.

Code	Description	Solution
Err01	Out of Measuring Range	Measure in a Proper Range
Err02	Reflected Signal is Too Weak	Select a Better Surface
Err03	Out of Display Range	Divide Calculation into Intermediate Steps
Err04	Pythagorean Calculation Error	Check and Verify Values and Steps are Correct
Err05	Low Battery	Install a New Battery
Err06	Out of Working Temperature	Measure in an Environment Within Specified Working Temperature
Err07	Ambient Light is Too Strong	Measure in a Darker Place or at a Darker Time

Table 1

MAINTENANCE/REPAIR

Upon final installation of the Model DDM-01, no routine maintenance is required besides changing the batteries. The Model DDM-01 is not field serviceable and should be returned if repair is needed. Field repair should not be attempted and may void warranty.

WARRANTY/RETURN

Refer to "Terms and Conditions of Sale" in our catalog and on our website. Contact customer service to receive a Return Goods Authorization number before shipping the product back for repair. Be sure to include a brief description of the problem plus any additional application notes.

