

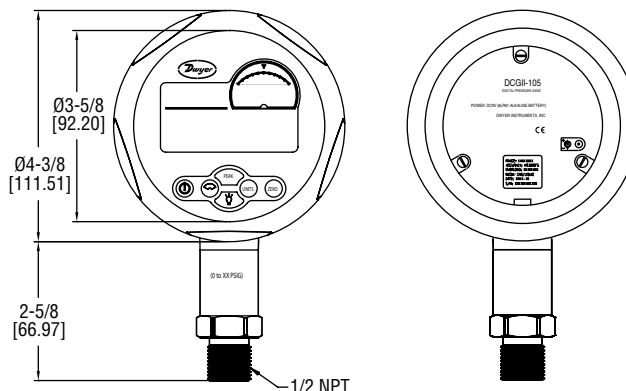

Series DCGII Digital Calibration Pressure Gauge

Specifications - Installation and Operating Instructions



The **SERIES DCGII** Digital Calibration Pressure Gauge offers a complete pressure gage with calibration capabilities. With a precise 0.05% full scale accuracy and large 5 digit resolution, this gage can be used in critical industrial applications where precision is most important. This versatile gage only requires one 9V alkaline battery or power adapter and can operate up to 5,000 working hours. The Series DCGII 0.05% Digital Pressure Gauge can display percent pressure for a quick visual reference. This pressure gage comes complete with eleven selectable pressure units, backlight and zeroing capability.

CAUTION To prevent sensor damage, do not allow the pressure to exceed 120% of full scale. The DCGII has 11 different pressure units to switch. However, in order to avoid the reading overflow or too low to read; only some of pressure units are selected. To prevent damage, do not use the imposition of torque between the shell and the pressure quick connect coupling. Do not connect the communication label with DCGII in a hazardous atmosphere.

SPECIFICATIONS

Service: Compatible, non-combustible liquids and gases.
Wetted Materials: 316 SS.
Other Materials: Housing: Aluminum alloy; Display: Acrylic MR200; Buttons: Silicon gel; Back plate: 304 SS; Back seal: Oil-proof latex.
Accuracy: 0.05% FS; ± 1 least significant digit.
Temperature Accuracy: $\pm 1^\circ\text{C}$.
Pressure Limits: 120% of FS.
Temperature Limits: 14 to 122°F (-10 to 50°C).
Compensated Limits: 32 to 122°F (0 to 50°C).
Process Connection: 1/2" male NPT.
Display: 5-digit LCD with blue backlight.
Power Requirements: One 9V alkaline battery or power adapter.
Battery Life: Up to 5,000 hours (600 working hours @ default 3 times/s).
Auto Shut-off: Backlight: On/off, 10 s, 20 s, 30 s.
Weight: 1.28 lb (0.58 kg).
Agency Approvals: CE.

OPERATING INSTRUCTIONS



Power ON/OFF



Analog dial:
Pressing it shortly to select the % indication, swing (fluctuation) and low/high alarm; Pressing it longer to enter into the menu of adjusting low/high alarm.



Peak Value:
Pressing it shortly to switch the indication among max Peak, min Peak and quit Peak; Pressing it longer to enter the menu of MENU OPTION.



Backlight:
Pressing it shortly to turn on or turn off the backlight; Pressing it longer to select the backlight display time (10 s, 20 s and 30 s), and loosen it for selection.



Pressure units:
Pressing it shortly to switch the different pressure units; Pressing it longer to enter into the temperature display menu.



Zeroing:
Pressing it for zeroing function (The absolute type DCGII should be press longer).

Data Inputting Introduction

1. (←), (→) Move decimal digit left and right;
2. (↑), (↓) Increase/ decrease the pressure value;
3. (↵) Confirm the inputting data;
4. (ESC) Cancel the inputting data.

Menu Operation Introduction

1. (Menu) Pressing it longer to enter the MENU OPTION (calibration/setting);
2. (↑), (↓) Move menu upper or down;
3. (↵) Enter function;
4. (ESC) Show the previous menu.

Screen Area

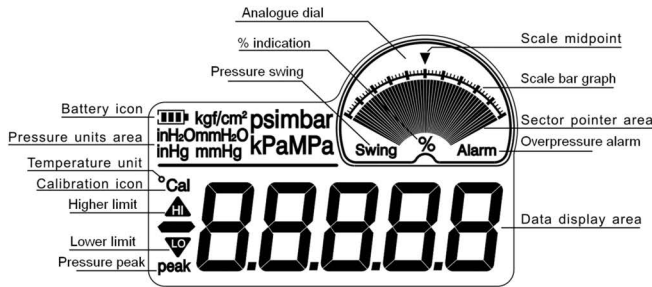

Figure 1: Screen Area

Battery Icon: The battery icon () is the indication of full battery; The battery icon () is the indication of low battery (<25%). However, the DCGII can continually work till it powers off automatically.

Pressure Unit Area: Total 11 units for selection; In order to avoid the readings overflow or too low to read, only some of pressure units are selected.

Calibration Icon: The mark or symbol of operating calibration.

Pressure Peak: The mark or symbol of displaying peak value.

Higher Limit: The mark or symbol of high limit pressure.

Lower Limit: The mark or symbol of lower limit pressure.

Temperature Unit: C, Celsius.

Data Display Area: To display all data or menu.

Analog Dial: Includes 3 types indication: pressure % indication, pressure swing, overpressure alarm.

The content of the area as below:

1. **% Indication:** The current pressure percentage;
2. **Pressure Swing:** The indication of the pressure fluctuation;
3. **Overpressure Alarm:** The alarm indication for overpressure (less or more the limit);
4. **Sector Pointer Area:** Including 51 segments bars or pointers;
5. **Scale Bar Graph:** It has different definitions under the different operation condition;
6. **Scale Midpoint:** The middle position of Scale bar graph.

Basic Function

Power on/off

Press to turn on or turn off the DCGII. The instrument does a self test and then shows all applicable data.

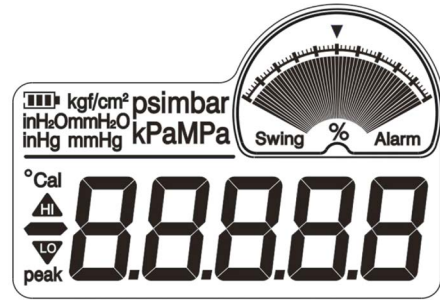

Figure 2: The First Screen

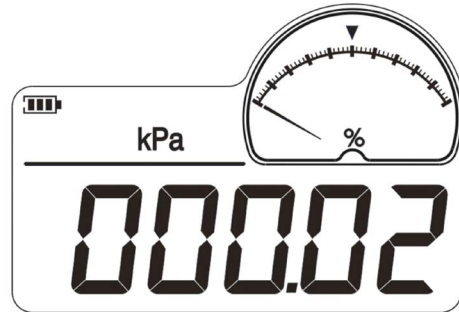

Figure 3: Pressure Measurement Interface

Pressure Measure

Press the buttons to enter the pressure measure menu, the displayed content includes:

- Battery icon
- Pressure measure value
- Pressure units
- Analogue dial indication

Note: Initially, these register values are set to the factory calibration values. If the pressure is over $120\% \times FS$, the whole screen will flash to alarm. To prevent damage of sensor, please release the pressure immediately. While the alarm happened, the measure speed of DCGII automatically changes to $3 \times 1 \text{ s}$ for catching up the pressure changing. When the alarm is over, the speed will go back to normal.

Zeroing

Connect the DCGII with atmosphere via connector coupling. If the current pressure is in the range of $(-1\% \sim +1\%) \times FS$, press button for zeroing step. Figure 4 shows the zeroing sequence of gage pressure.

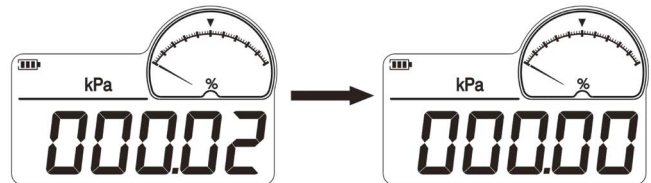



Figure 4: The Zeroing Sequence for Gage Pressure DCGII

Pressure Units

Press  button to switch different pressure units. The sequence is kPa > kgf/cm² > inH₂O > mmH₂O > inHg > mmHg > psi > mbar > bar > Mpa.

Peak Detection

1. Record maximum/minimum peak value

Press  button to record the peak value.

 -----Show the maximum pressure

 -----Show the minimum pressure

<No Icon>----- Automatically record the actual pressure value.

2. Reset the Peak Values

Press  button to cancel the previous peak value and save the current peak value.

Backlight

Press  button to power on/off the backlight. Hold button to set auto on/off to 10 s, 20 s and 30 s.

Analogue dial

Includes three indications: % indication, pressure swing and overpressure alarm

Press  button to switch each other.

The analogue dial includes:

1. Percent pressure (%)
2. Pressure swing
3. Overpressure alarm
4. Sector pointer area
5. Scale bar graph
6. Scale midpoint

Percent Pressure

% indication: show the current pressure percentage;

Sector pointer area: show the pressure range as sector shape;

Scale bar graph: 0%~100%, the minimum scale is 2%;

Scale midpoint: point to 50%.

Pressure Swing

Pressure swing icon: The indication of the pressure fluctuation;

Sector pointer area: By using 1 pointer, to show the fluctuation degree of 2 seriate pressure value;

Scale bar graph: Range is $(-0.25\% \sim 0.25\%) \times FS$, the minimum scale is $0.01\% \times FS$;

Scale midpoint: Point to $0.01\% \times FS$ position.

Overpressure Alarm

Overpressure alarm icon: The indication of the overpressure;





Sector pointer area: By using 2 pointers to show the high/low alarm limit, the 3rd pointer to show the current pressure %



Scale bar graph: $(0\% \sim 100\%) \times FS$, minimum scale is $2\% \times FS$;

Scale midpoint: Point to 50%.

Set Alarm Limit

The setting process as follows:

1. Press  button to display the higher limit () and lower limit () in turn, please move the cursor left or right direction by pressing the  button.



2. Press  button to adjust the alarm higher limit () or lower limit ().

3. After the high limit is adjusted, the menu will automatically enter the lower limit, and then to quit the menu.

The sequence is: High limit > Low limit > Quit.

4. The DCGII automatically checks the validity for inputting data. If there is a problem, the setting is not effective.

Temperature Measure

Press  button longer to enter the menu of temperature measure, press  again to go back to the pressure measure menu.

The temperature measure range is -30°C to 90°C , the minimum resolution is $\pm 0.1^{\circ}\text{C}$.

Menu Option (Calibration/Setting)

Enter the Menu

The password to enter the menu is "211". The operation steps as follows:

Press  longer to enter into the password menu.

Input password "211".

Note: If the password is wrong, the menu will return to the previous menu.

Menu Option:

There are 4 options, as shown.



Description:

1.  To enter into the calibration menu;

2.  The DCGII has been calibrated already;

 The DCGII hasn't been calibrated yet;

Note: If user implements this step, all pressure calibration will be canceled. Please be careful with this option.

3.  To cancel the previous zeroing operation;

4.  To set measure speed (or display update).

Enter/Cancel the Calibration

 To enter the calibration.

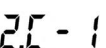
 To cancel the calibration.

Cancel the Wrong Zeroing

3.01 To cancel the previous zeroing operation.

Measurement Speed

Select **4.9t** to enter the selectable menu of measure speed, as follows:
 1-3 (3 x 1 s) 1-2 (2 x 1 s) 1-1 (1 x 1 s) 2-1 (1 x 2 s)

3-1 (1 x 3 s) 4-1 (1 x 4 s) 5-1 (1 x 5 s) 6-1 (1 x 6 s)

7-1 (1 x 7 s) 8-1 (1 x 8 s) 9-1 (1 x 9 s) 10-1 (1 x 10 s)

The factory default is 3 x 1 s.

Calibration Function

It is recommended the DCGII is re-calibrated once a year by a skilled professional. Otherwise, the random operation may be effects the inner parameter and weaken the measure performance. The DCGII should be pressurized to full scale then release all pressure. In order to achieve the best calibration condition, please do the pre-pressurizing at least three times.

Calibration Conditions

1. Environment: Temperature: 20 ± 2°C; Relative humidity: (45-75% RH); Atmosphere pressure: (25.4-31.3 in Hg).
2. Standard pressure source.

Calibration Process

Select Menu **1.CAL** to enter the calibration menu.

1. Select **1.CAL** and press **zero** button to display the calibration value of lower limit, as Figure 5. If you need to modify this calibration value, please input the desired value. Otherwise, please press **zero** button to confirm.

2. To calibrate lower limit point: Press **zero** button to confirm till the actual pressure value is stable.

3. Display higher limit point: Input the desired data if user needs to modify the calibration value. Otherwise, press **zero** button to confirm.

4. To calibrate higher limit point: Press **zero** button to confirm until the actual pressure value is stable.

5. The screen returns to the calibration menu, the 2nd option changes to **2.C - 1** That shows the calibration is finished and effective.

Cancel Calibration

Select **2.C - 1** to cancel the calibration, then the screen displays **2.C - 0**

Replacing the Battery

Please replace with spare battery if the DCGII powered off automatically; Replace the approved battery.
 Approved battery: 9V alkaline
 Unscrew the 3 screws and remove the battery cover, install the new battery.

MAINTENANCE/REPAIR

Upon final installation of the Series DCGII, no routine maintenance is required. The Series DCGII is not field serviceable and should be returned if repair is needed. Field repair should not be attempted and may void warranty.

WARRANTY/RETURN

Refer to "Terms and Conditions of Sales" in our catalog and on our website. Contact customer service to receive a Return Goods Authorization number before shipping the product back for repair. Be sure to include a brief description of the problem plus any additional application notes.

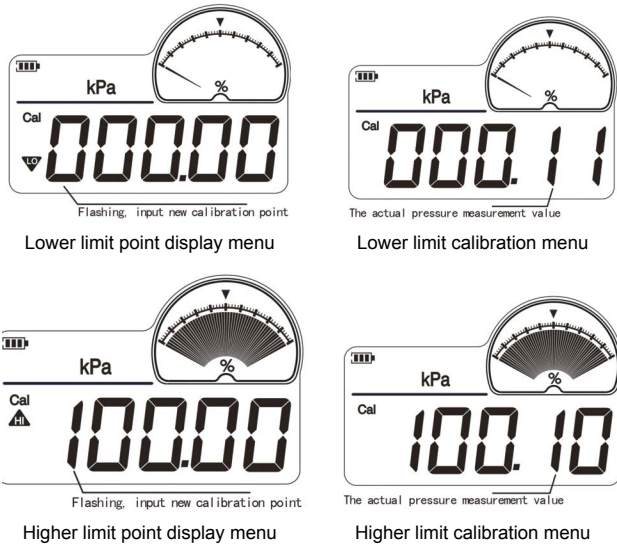

Figure 5: Limits