

DIGITAL CLAMP METER

OPERATION MANUAL

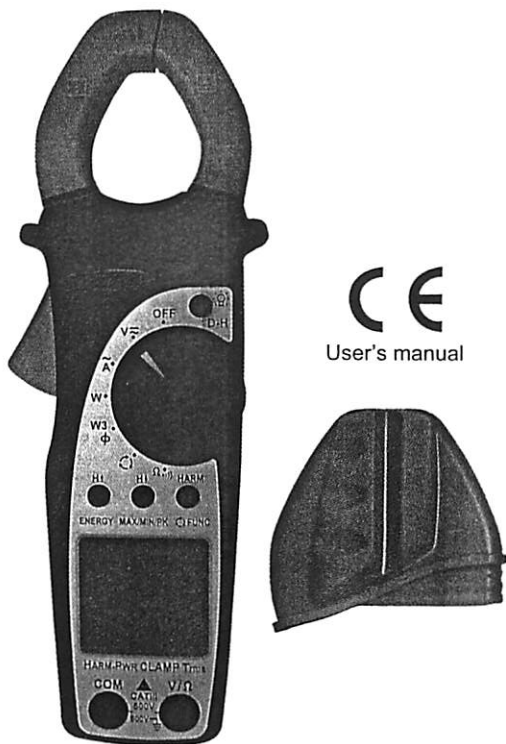

CONTENTS:

| | |
|---|----|
| DIGITAL CLAMP METER | 1 |
| 1. SAFETY PRECAUTIONS AND PROCEDURES | 2 |
| 1.1. Preliminary instructions | 2 |
| 1.2. During use | 3 |
| 1.3. After use | 3 |
| 1.4. Definition of measuring (overvoltage) category | 3 |
| 2. GENERAL DESCRIPTION | 4 |
| 3. PREPARATION FOR USE | 5 |
| 3.1. Preliminary checks | 5 |
| 3.2. Power supply | 5 |
| 3.3. Calibration | 5 |
| 3.4. Storage | 5 |
| 4. OPERATING INSTRUCTIONS | 6 |
| 4.1. Instrument description | 6 |
| 4.1.1. Controls description | 6 |
| 4.1.2. Alignment marks | 6 |
| 4.1.3. Rubber cap use to hold test leads | 7 |
| 4.1.4. AUTO POWER OFF function | 7 |
| 4.2. Description of function keys | 7 |
| 4.2.1. FUNC key | 7 |
| 4.2.2. D-H / key | 8 |
| 4.2.3. MAX/MIN/PK key | 8 |
| 4.2.4. ENERGY key | 8 |
| 4.3. Description of rotary switch functions | 9 |
| 4.3.1. AC / DC voltage measurement | 9 |
| 4.3.2. Frequency measurement (With test leads) | 10 |
| 4.3.3. Measurement of voltage harmonics | 11 |
| 4.3.4. Resistance and continuity measurement | 12 |
| 4.3.5. AC current measurement | 12 |
| 4.3.6. Frequency measurement (from the jaws) | 13 |
| 4.3.7. Measurement of current harmonics | 14 |
| 4.3.8. Power measurements on single phase systems | 15 |
| 4.3.8.1. Energy measurements on single phase systems | 16 |
| 4.3.9. Power measurements on three phase balanced systems | 17 |
| 4.3.9.1. Energy measurement on three phase balanced systems | 18 |
| 4.3.10. Detection of phase sequence | 18 |
| 4.3.10.1. Detection of phase coincidence | 21 |
| 4.3.10.2. Phase detection | 22 |
| 5. MAINTENANCE | 23 |
| 5.1. General information | 23 |
| 5.2. Battery replacement | 23 |
| 5.3. Cleaning | 23 |
| TECHNICAL SPECIFICATIONS | 23 |
| 5.4. Characteristics | 23 |
| 5.4.1. Safety standards | 24 |
| 5.4.2. General data | 25 |
| 5.5. Environmental conditions | 25 |
| 5.5.1. Climatic conditions | 25 |
| 5.5.2. EMC | 25 |
| 5.6. Accessories | 25 |
| 6. SERVICE | 25 |
| 7. APPENDIX: VOLTAGE AND CURRENT HARMONICS | 26 |
| 7.1. Theory | 26 |
| 7.2. Limit values for harmonics | 27 |
| 7.3. Causes for the presence of harmonics | 27 |
| 7.4. Consequences of the presence of harmonics | 28 |

1. SAFETY PRECAUTIONS AND PROCEDURES

This instrument is designed in compliance with EN 61010 directive. For your own safety and to avoid damaging the instrument, we suggest you to follow the procedures hereby prescribed and to read carefully all the notes preceded by the symbol .



WARNING

Should you fail to follow the prescribed instructions you could damage the instrument and/or its components or endanger your safety.

Take extreme care to the following conditions while taking measurements:

- Do not measure voltage or current in humid or wet environments.
- Do not use the clamp in the presence of explosive gas (material), combustible gas (material), steam or dust.
- Do not touch the circuit under test if no measurement is being taken;
- Do not touch exposed metal parts, unused terminals, circuits and so on;
- Do not use the instrument if it seems to be malfunctioning. (i.e. When you notice deformations, breaks, leakage of substances, absence of segments on the display and so on);
- Be careful when you measure voltages exceeding 20V as you may risk electrical shocks;
- Not allow with your hands to pass over the Safety Guard (see Fig. 1, pos.2) on current measurements and voltage measurements using the holster.

The following symbols are used:



Caution: Refer to the instruction manual. Incorrect use may damage the tester or its components



High voltage danger: Risk of electric shocks



Double insulated meter



AC voltage or current



DC voltage or current



Application around and removal from hazardous live conductors is permitted

1.1. PRELIMINARY INSTRUCTIONS

- This clamp meter is designed for use in the environment of pollution degree 2.
- It can be used for **CURRENT** measurements on installations of over voltage category III up to 600V (Voltage between phase and earth) and for **VOLTAGE** and

FREQUENCY measurements on installations of over voltage category III up to 600V (Voltage between terminals and between phase and earth).

- Please use the standard safety precautions aimed at:
 - ◆ Protect you against dangerous electric currents.
 - ◆ Protect the instrument against incorrect operations.
- Only the leads supplied with the instrument guarantee compliance with the safety standards. They must be in a good condition and, if necessary, replace only with identical leads.
- Do not test circuits exceed the current and voltage limits.
- Do not perform any test under environmental conditions which exceed the limits indicated in paragraphs 6.2.1.
- Assure the batteries are installed correctly.
- Before connecting the test leads to the circuit, make sure the rotary selector switch is set to the correct function.
- Make sure that LCD and rotary selector switch indicate the same function.

1.2. DURING USE



WARNING

Non compliance with warnings and/or instructions may cause damage to the tester or its components or injure the operator.

- Remove the clamp jaw from the conductor or circuit under test before changing the range.
- When the tester is connected to the measuring circuits, do not touch any unused terminal.
- Do not measure resistance in the presence of external voltages. Even if the circuit is protected, excessive voltage may cause the instrument to malfunction.
- When measuring current with the clamp jaws, first remove the test leads from the input jacks.
- When measuring current, any other source near the clamp jaw could affect its accuracy.
- When measuring current, always put the conductor to be tested in the middle of the clamp jaw to obtain the most accurate reading as referred into paragraph 4.1.2.
- While measuring, if the value remains unchanged, check the HOLD function is enabled or not.

1.3. AFTER USE

- After taking measurement, please turn off the meter.
- If the instrument will not be used for a long period, recommend to remove the batteries.

1.4. DEFINITION OF MEASURING (OVERVOLTAGE) CATEGORY

The norm EN 61010: Safety requirements for electrical equipment for measurement, control and laboratory use, Part 1: General requirements, defines what a measuring category, usually called overvoltage category, is.

Circuits are divided into the following measurement categories:

- **Measurement category IV** is for measurements performed at the source of the low-voltage installation.
Examples: Electricity meters and measurements on primary over-current protection devices and ripple control units.
- **Measurement category III** is for measurements performed in the building installation.
Examples: Measurements on distribution boards, circuit breakers, wiring, including cables, bus-bars, junction boxes, switches, socket-outlets in the fixed installation, and equipment for industrial use and some other equipments, for example: Stationary motors with permanent connection to fixed installation.
- **Measurement category II** is for measurements performed on circuits directly connected to the low voltage installation.
Examples: Measurements on household appliances, portable tools and similar equipments.
- **Measurement category I** is for measurements performed on circuits not directly connected to MAINS.
Examples: are measurements on circuits not derived from MAINS, and specially protected (internal) MAINS-derived circuits. In the latter case, transient stresses are variable; for that reason, the norm requires that the transient withstand capability of the equipment is made known to the user.

2. GENERAL DESCRIPTION

Thank to a new development concept assuring double insulation as well as compliance with category III up to 600V, you can rely on the utmost safety conditions (see chapter 1.4).

This instrument performs the following functions:

- AC voltage (V_{AC}) with TRMS conversion mode.
- DC voltage (V_{DC}).
- AC current (I_{AC}) with TRMS conversion mode.
- Harmonic AC voltage (from DC to 25th components)
- Harmonic AC current (from 1st to 25th components).
- Frequency with input test leads.
- Frequency with clamp jaws.
- Resistance.
- Continuity test.
- Phase rotation with only one test lead.
- Active, reactive, apparent power and power factor measure on single-phase systems.
- Active, reactive, apparent power and power factor measure on balanced three-phase systems.
- Active, reactive, apparent energy measurements on single-phase systems.
- Active, reactive, apparent energy measurements on balanced three-phase systems.

Each parameter can be selected by using 7-position rotary switch, including an OFF position. There are buttons: "O FUNC", "MAX/MIN/PK", "ENERGY" and "D-H / *" or "O FUNC / HARM", "MAX/MIN/PK / H↓", "ENERGY / H↑" and "D-H / *". Please see paragraph 4.2. The selected quantity appears on a high-contrast display with unit and function indication.

3. PREPARATION FOR USE

3.1. PRELIMINARY CHECKS

This instrument has been checked its mechanically and electrically before shipment. All precautions have been taken to assure that the instrument reaches you in perfect condition.

However, it is advisable to carry out a rapid check in order to detect any possible damage, which might have occurred in transit.

Check the accessories contained in the packaging to make sure they are the same as reported in paragraph 6.3.1.

3.2. POWER SUPPLY

The instrument is supplied with 2 AAA batteries. The instruments battery life is about 90 hours.

The  symbol appears when the batteries are nearly discharged. Replace them by following the instructions in paragraph 5.2.

3.3. CALIBRATION

The tester complies with the accuracy specifications listed in this manual and such compliance is guaranteed for one year, afterwards the tester may need recalibration.

3.4. STORAGE

In order to guarantee the accuracy of the measurements, after a period of storage in extreme environmental conditions wait for the tester to stabilize to within the specified operating conditions (see environments specifications paragraph 6.2.1) before use.

4. OPERATING INSTRUCTIONS

4.1. INSTRUMENT DESCRIPTION

4.1.1. Controls description

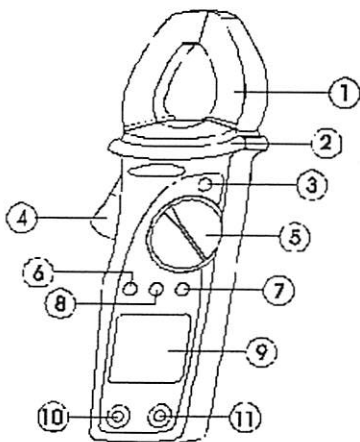

LEGEND:

1. Inductive clamp jaw.
2. Safety guard.
3. D-H, ⊗ key.
4. Jaw trigger.
5. Rotary selector switch.
6. ENERGY / H↑ key.
7. ⊙ FUNC / HARM key.
8. MAX/MIN/PK / H↓ key.
9. LCD display.
10. COM jack.
11. V/Ω jack.

Fig. 1: Instrument description

4.1.2. Alignment marks

Put the conductor within the jaws on intersection of the indicated marks as close as possible (see Fig. 2) in order to meet the meter accuracy specifications.

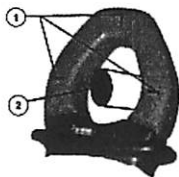

LEGEND:

1. Alignment marks.
2. Conductor.

Fig. 2: Alignment marks.

4.1.3. Rubber cap use to hold test leads

A rubber holster is provided with the instrument. This standard accessory is applied to hold the test leads when fitted on the top of the clamp, see Fig. 3.



Fig. 3: Utilize rubber test lead holster

This rubber holster is a very practical use. It allows the user to perform the measurement with both test leads while observing the value on the display at the same time.

4.1.4. AUTO POWER OFF function

In order to extend the battery life, the instrument automatically switches off in 5 minutes after the last rotary switch or button actuation.

When this function is enabled, the symbol ⓪ is displayed.

To disable this function, rotate the selector to the OFF position, then rotate the selector to any position while the ⓪ FUNC key is pressed.

Rotating the selector switch to the OFF position, then back to any function again will re-enable the AUTO POWER OFF function.

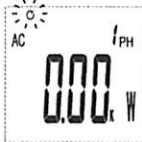

4.2. DESCRIPTION OF FUNCTION KEYS

4.2.1. ⓪ FUNC key

It allows the user to cycle through each function's measurement modes by each key press.

- $V \sim$: Press ⓪ FUNC key to select between voltage and frequency measurement.
- $A \sim$: Press ⓪ FUNC key to select between current and frequency measurement.
- ⓪ : Press ⓪ FUNC key to start phase sequence detection.
- W : Press ⓪ FUNC key to select among active energy, reactive energy, apparent energy, and power factor measurements on a single-phase system.

- **W3Φ**: Press **FUNC** key to select among active energy, reactive energy, apparent energy, and power factor measurements on three phase balanced systems.

Press & hold **FUNC** key at least 1 second to activate the "Harmonic measurement mode". With the rotary selector switch under the following positions:

- **V \sim** : Press and hold **FUNC** key at least 1 second to activate the voltage harmonic measurement. By pressing the **H \uparrow** and **H \downarrow** keys, the individual harmonic values are displayed.
- **A \sim** : Press and hold **FUNC** key at least 1 second to activate the current harmonic measurement. By pressing the **H \uparrow** and **H \downarrow** keys, the individual harmonic values are displayed.

This function mode is disabled by:

- Press and hold **FUNC** key for 1 second.
- Rotate the selector to any position.

More details about **FUNC** key use are specified in the measurement paragraphs.

4.2.2. D-H / HOLD key

It enables HOLD function. Symbol HOLD is displayed when this function is enabled. To disable this function:

- Press **D-H** key again
- Rotate the rotary selector switch to any other position.

Press and hold HOLD key for 1 second to illuminate the backlight. The backlight automatically turns off about 5 seconds after the last rotary selector switch or button actuation.

4.2.3. MAX/MIN/PK key

Press and hold **MAX/MIN/PK** key at least 1 second, the instrument activates the maximum (**MAX**), minimum (**MIN**), average (**AVG**) or peak (**PK**) measurement modes. All of these values are continually updated even if only one of them is displayed. By repeatedly pressing **MAX/MIN/PK** key, each value is displayed with the corresponding frequency. To escape this function:

- Press and hold **MAX/MIN/PK** key at least 1 second.
- Rotate the selector to any position.

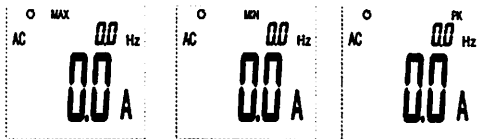

4.2.4. ENERGY key

With the rotary selector on "**W**" or "**W3Φ**" position, press and hold this key at least 1 second to activate the energy measurement.

- **W:** Press **ENERGY** key to start active energy, reactive energy, apparent energy or power factor measurements on single-phase system. Press **FUNC** key, every single parameter value is displayed.
- **W3Φ:** Press **ENERGY** key to start the active energy, reactive energy, apparent energy or power factor measurements on three phase-balanced systems. Press **FUNC** key, every parameter value is displayed.

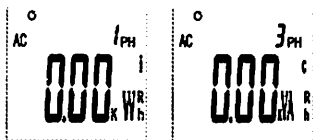

4.3. DESCRIPTION OF ROTARY SWITCH FUNCTIONS

4.3.1. AC / DC voltage measurement



WARNING

- The maximum Voltage input is 600V. Do not attempt to take any voltage measurement which exceeds the limits that indicated in this manual. Exceeding the limits may cause electrical shock or damage to the instrument.
- The instrument won't measure any AC value less than 1.5V.

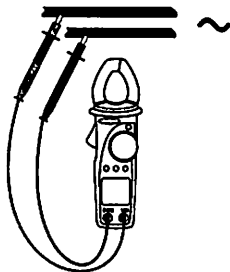

Fig. 4: AC voltage measurement

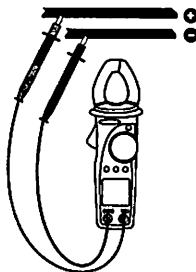
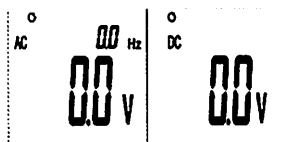

Fig. 5: DC voltage measurement

1. Select **V~** position.
2. Plug with red lead into **V/Ω** jack and plug the black lead into the **COM** jack. For ease of use, attach the rubber holster and insert a test lead (see Fig. 3).
3. Connect the test leads to the circuit under test (see Fig. 4 and Fig. 5). The instrument automatically selects AC or DC. For AC voltage measurements, the frequency value is shown on the secondary display.
4. The **-** symbol indicates a negative DC voltage polarity.

5. The "O.L." symbol indicates a voltage higher than the full-scale capability of the instrument.



4.3.2. Frequency measurement (With test leads)



WARNING

- The maximum Voltage input is 600V. Do not attempt to take any voltage measurement which exceeds the limits indicated in this manual. Exceeding the limits could cause electrical shock or damage to the instrument.
- The instrument won't measure any AC value less than 1.5V.

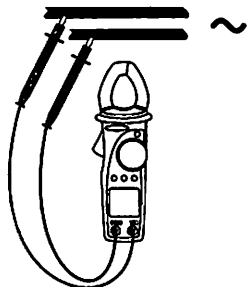
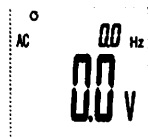

Fig. 6: Frequency measurement with test leads

1. Select "V~" position. Press **FUNC** key to select Hz function (in AC mode).
2. Press **FUNC** key again to return to the voltage measurement function.
3. Insert red plug into V/Ω jack and the black plug into the COM jack. For ease of use, attach the rubber holster and insert a test lead (see Fig. 3).
4. Connect the test leads to the circuit under test (see Fig. 6). The measured frequency value is displayed.
5. "O.L." symbol indicates a voltage higher than the full-scale capability of the instrument.



4.3.3. Measurement of voltage harmonics



WARNING

- The maximum voltage input is 600V. Do not attempt to take any voltage measurement which exceeds the limits indicated in this manual. Exceeding the limits could cause electrical shock or damage to the instrument.
- Harmonic voltage measure is active for AC voltage on inputs only.

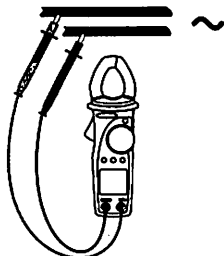

Fig. 7: Voltage harmonic analysis

1. Select "**V**~" position. Press and hold **FUNC** key at least 1 second until symbol "**THD%**" is displayed.
2. Insert red plug into **V/Ω** jack and the black plug into **COM** jack. For ease of use, attach the rubber test lead holster and hold a test lead as seen on Fig. 3.
3. Connect the test leads to the circuit under test (see Fig. 6). The instrument displays the Total Harmonic Distortion value of the input signal. The symbol "**THD%**" is shown on the display. See chapter 0 for the parameter's definition.
4. With **H↑** and **H↓** keys, you can cycle through all available harmonic values from DC to the 25th order. On the secondary display shows the order of the harmonic whose percentage value is displayed on the main one (ex. **H3%** means the third harmonic).
5. Press **FUNC** key to switch to the absolute harmonics' values displaying (from DC to 25th order). On the secondary display shows the order of the harmonic whose absolute value is displayed on the main one (ex. **H3** means the third harmonic).



4.3.4. Resistance and continuity measurement



WARNING

Before attempting any resistance measurement remove the power from the circuit under test and discharge all the capacitors, if present.

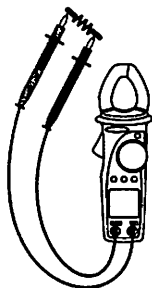
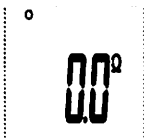

Fig. 8: Resistance and continuity measurements

1. Select " Ω " position.
2. Insert red plug into V/ Ω jack and the black plug into COM one. For an easy measurement, use the rubber test lead holster with one test lead (see Fig. 3).
3. Connect test leads to the circuit under test (see Fig. 8). The measured resistance value is displayed.
4. An audible beep sounds when the measured value is lower than 40Ω .
5. Symbol "O.L" stands for the measured voltage is higher than the full scale of the instrument.



4.3.5. AC current measurement



WARNING

Before attempting any measurement, disconnect all the test leads from the circuit under test and from the meter's input terminals.

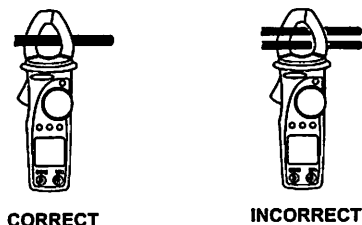
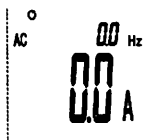

Fig. 9: AC current measurements

1. Select "A~" position.
2. Open the jaws and clamp with only one cable. Pay attention to the alignment marks (see paragraph 4.1.2. and Fig. 9). The values of current and frequency are shown on the main and secondary displays.
3. Symbol "O.L." stands for the measured voltage is higher than the full scale of the instrument.



4.3.6. Frequency measurement (from the jaws)



WARNING

Before attempting any measurement disconnect all the test leads from the circuit under test and from the meter's input terminals.

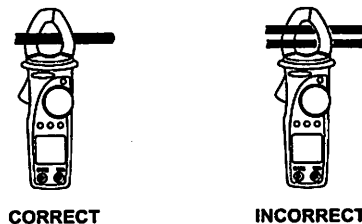
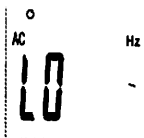

Fig. 10: Frequency measurements from the jaws

1. Select "A~" position. Press \odot FUNC key to select Hz function.
2. Open jaw and clamp with only one cable. Pay attention to the alignment marks (see paragraph 4.1.2. and Fig. 10). The value of frequency is shown on main display.
3. Symbol "O.L." stands for the measured voltage is higher than the full scale of the instrument.
4. Press \odot FUNC key to escape this mode for going back to current measurement function (see paragraph 4.3.5).



4.3.7. Measurement of current harmonics



WARNING

Before attempting any measurement disconnect all the test leads from the circuit under test and from the meter's input terminals.

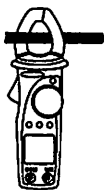

CORRECT

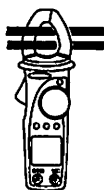

INCORRECT

Fig. 11: Harmonic current measurement

1. Select "A~" position. Press and hold \odot FUNC key at least 1 second until symbol "THD%" is displayed.
2. Open the jaw and clamp with only one cable. Pay attention to the alignment marks (see paragraph 4.1.2. and Fig. 11). The instrument displays the Total Harmonic Distortion value of the input signal and symbol "THD%" is displayed. See chapter 0 for the parameter's definition.
3. With H \uparrow and H \downarrow keys, you can cycle through all available harmonic values from the 1st to the 24th order. Secondary display shows the order of the harmonic whose percentage value is displayed on the main one (ex. H3% means the third harmonic).

4. Press **FUNC** key to switch to the absolute harmonics' values displaying (from the 1st to the 25th order). The secondary display indicates the order of the harmonic whose absolute value is displayed on the main one (ex. H3 means the third harmonic)

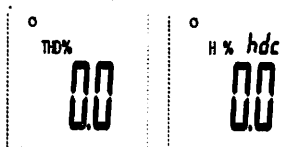

4.3.8. Power measurements on single phase systems



WARNING

The maximum Voltage input is 600V. Do not attempt to take any voltage measurement which exceeds the limits indicated in this manual. Exceeding the limits could cause electrical shock or damage to the instrument.

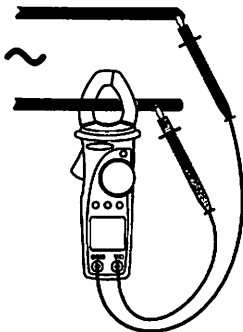
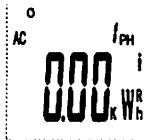



Fig. 12: Power and energy measurement on single phase systems

1. Select **"W"** position.
2. Open the jaw and clamp with only one cable. Pay attention to the alignment marks (see paragraph 4.1.2. and Fig. 12).
3. Insert the red plug into V/ Ω jack and the black plug into COM one.
4. Connect the test leads to the circuit under test (see Fig. 12). The measured active power value and symbol **"AC"** is displayed.
5. If symbol **" Δ "** is displayed, it stands for the input voltage and/or current value is higher than the instrument's full scale. Therefore the power and power factor values could be incorrect.
6. Press **FUNC** key, the following parameters are shown:
 - Active power (kW);
 - Reactive power (kVA^R, capacitive C, inductive I);

- Apparent power (kVA);
- Power factor (Pfi or Pfc for inductive and capacitive respectively).



4.3.8.1. Energy measurements on single phase systems

1. Select "W" position.
2. Open the jaw and clamp with only one cable. Pay attention to the alignment marks (see paragraph 4.1.2. and Fig. 12).
3. Insert the red plug into V/Ω jack and the black plug into COM one.
4. Connect the test leads to the circuit under test (see Fig. 12). The measured active power value and symbol "AC" is displayed.
5. If symbol "Δ" is displayed, the input voltage and/or current value is higher than the instrument's full scale, the power and power factor values may be incorrect.
6. Press and hold ENERGY key at least 1 second to active the energy measurement mode.
7. Press  FUNC key the following parameters are displayed:
 - Active energy (kWh);
 - Reactive energy (kVA^Rh, capacitive C, inductive I);
 - Apparent energy (kVAh);
 - TIME with indication of energy measurement duration.
8. Press ENERGY key to activate the energy measurement. The message "MEASURING" appears on the screen, press ENERGY key again to stop the energy measurement, now "MEASURING" disappears from the display.
9. Press and hold ENERGY key at least 1 second to escape from the energy measurement mode.

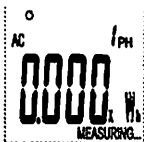

4.3.9. Power measurements on three phase balanced systems



WARNING

The maximum input for Voltage measurements is 600V. Do not attempt to take any voltage measurement which exceeds the limits indicated in this manual. Exceeding the limits could cause electrical shock at the operator and damages to the clamp meter.

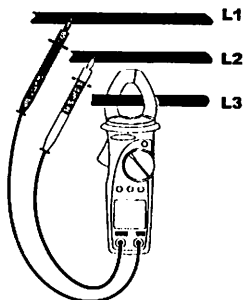
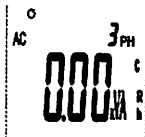

Fig. 13: Power and energy measurement on three phase balanced systems

1. Select **"W3Φ"** position.
2. Open the jaw and clamp with L3 phase cable. Pay attention to the alignment marks (see paragraph 4.1.2. and Fig. 13).
3. Insert red plug into V/Ω jack and the black plug into COM one.
4. Connect red test lead to L1 phase conductor and the black test lead to L2 phase conductor (see Fig. 13). The measured active power value and symbol "AC" is displayed.
5. If symbol " Δ " is displayed the input voltage and/or current value is higher than the instrument's full scale. Therefore the power and power factor values could be incorrect.
6. Press **FUNC** key, the following parameters are displayed:
 - Active power (kW);
 - Reactive power (kVA^R, capacitive C, inductive I);
 - Apparent power (kVA);
 - Power factor (Pfi or Pfc for inductive and capacitive respectively).



4.3.9.1. Energy measurement on three phase balanced systems

1. Select **"W3Φ"** position.
2. Open the jaws and clamp with L3 phase cable. Pay attention to the alignment marks (see paragraph 4.1.2. and Fig. 13).
3. Insert the red plug into V/Ω jack and the black plug into COM one.
4. Connect the red test lead to L1 phase conductor and the black test lead to L2 phase conductor (see Fig. 13). The measured active power value and symbol **"AC"** are displayed.
5. If symbol **"Δ"** is displayed, the input voltage and/or current value is higher than the instrument's full scale. That means the power and power factor values might not correct.
6. Push and hold **ENERGY** key at least 1 second to active the energy measurement.
7. Press **FUNC** key, the following parameters are displayed:
 - Active energy (kWh);
 - Reactive energy (kVA^Rh, capacitive C, inductive I);
 - Apparent energy (kVAh);
 - TIME with indication of energy measurement duration.
8. Press **ENERGY** key to activate the energy measurement. The counter is activated and **"MEASURING"** is showed on the bottom of the display. Press **ENERGY** key again to stop the energy measurement, **"MEASURING"** symbol disappears from the display.
9. Press and hold **ENERGY** key at least 1 second to escape energy measurement.



4.3.10. Detection of phase sequence



WARNING

The maximum Voltage input is 600V. Do not attempt to take any voltage measurement which exceeds the limits indicated in this manual. Exceeding the limits could cause electrical shock or damage to the instrument.

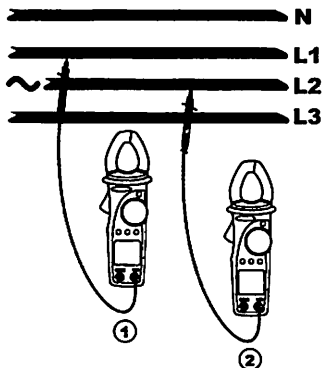

Fig.14: Phase rotation detection

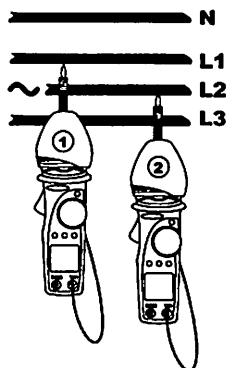

Fig.15: Phase rotation detection with rubber cup

1. Select "⊙" position. Insert red lead into V/Ω jack.
2. The symbol "1PH" will appear on the secondary display. The instrument is ready to perform the first measurement.
3. Connect the red terminal to the L1 phase conductor (see Fig.14, 1st measurement). If necessary, please use the rubber test lead holster and insert the red test lead (see Fig.15, 1st measurement).

WARNING



During the measurement:

- The instrument must be held in the operator's hand.
- The test lead cable must not be in contact with or near to any voltage source, as instrument sensitivity may abort the measurement.

4. When an input voltage greater than 80V is detected, the buzzer sounds and symbol "PH" is shown on the main display. Don't press any key and keep the test lead connected to L1 phase cable.

WARNING



If the input voltage value is less to 80V the instrument doesn't show "PH" symbol and it's not possible to execute the phase rotation detection.

5. After about one second "MEASURING" appears on the display which indicates the instrument is ready to execute the first measurement.
6. Press ⊙ FUNC key, "MEASURING" message will disappear.
7. Disconnect the test lead and the symbol "2PH" appears on the secondary display, the instrument is ready to perform the second measurement.
8. Connect the test lead to the L2 phase conductor (see Fig.14 or Fig.15, 2nd measurement).

9. When an input voltage greater than 80V is detected, the buzzer sounds and symbols "PH" is shown on the main display. Don't press any key and keep the test lead connected to L2 phase cable.

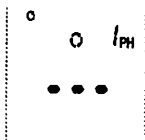

WARNING

If the input voltage value is less to 80V instrument doesn't show "PH" symbol and it's not possible to execute the phase rotation detection.

10. After about one second "MEASURING" appears on the display, it means the instrument is ready to execute the second measurement.
11. Press  FUNC key, "MEASURING" symbol message will disappear.



WARNING

If you wait more than 10 seconds between the first  FUNC key press and the second, the instrument will display the "SEC" message and it's necessary to repeat all the measurements from the beginning. Rotate the selector to any position to escape the function and restart at step 1.

12. If the two tested phases follow the correct sequence, the instrument displays "1.2.3.", otherwise it displays "2.1.3." which is an incorrect phase sequence.



WARNING

- The detected voltage is NOT the phase to neutral voltage, but the voltage between the conductor and the operator who is holding the instrument. This value can be lower than the phase to neutral voltage. **DON'T TOUCH THE PHASE CABLE IF YOU AREN'T SURE THAT ANY VOLTAGE IS PRESENT.**
- If the operator is insulated from the ground (e.g. insulated floors, shoes with rubber soles, etc.) the instrument may not measure correctly. We recommend repeating test at least twice due to verify the rightness of the obtained result.

4.3.10.1. Detection of phase coincidence

The purpose of this measurement is to verify the correct phase between 2 conductors before executing a parallel connection.

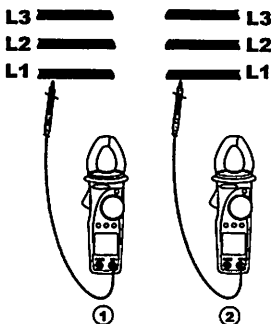

Fig. 16: phase detection

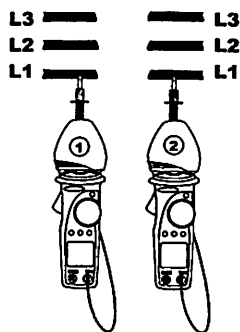

Fig. 17: phase detection with rubber cup

1. Select **⓪** position. Insert the red plug into V/Ω jack.
2. Symbol **"1PH"** is shown on the secondary display, the instrument is ready to perform the first measurement.
3. Connect the red terminal to the L1 phase conductor (see Fig. 16, 1st measurement). If necessary, use the rubber cup to insert red test lead (see Fig. 17, 1st measurement).
4. When an input voltage greater than 80V is detected the buzzer sounds and the symbols **"PH"** is shown on the main display. Don't press any key and keep the test lead connected to L1 phase cable.
5. After about one second **"MEASURING"** appears on the display indicating that the instrument is ready to execute the first measurement.
6. Press **⓪** FUNC key, **"MEASURING"** symbol will disappear.
7. Disconnect the test lead. Symbol **"2PH"** appears on the secondary display. The instrument is now ready to perform the second measurement.
8. Connect the test lead to the second cable (see Fig.14 or Fig.15, 2nd measurement).
9. When an input voltage greater than 80V is detected, the buzzer sounds and the symbols **"PH"** is shown on the main display. Don't press any key and keep the test lead connected to L1 phase cable.
10. After about one second **"MEASURING"** appears indicating the instrument is ready to execute the second measurement.
11. Press **⓪** FUNC key, the **"MEASURING"** symbol disappears.
12. If the two test cables belong to the same phase, the instrument displays **"1.1.-."**, otherwise it displays **"2.1.3."** or **"1.2.3."** This means that the two cables belong to two different phases.

4.3.10.2. Phase detection



WARNING

The maximum voltage input is 600V. Do not attempt to take any voltage measurement which exceeds the limits indicated in this manual. Exceeding the limits may cause electrical shock or damage to the instrument.

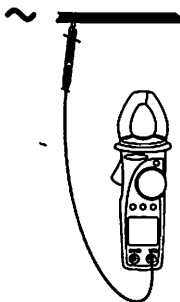

Fig. 18: Voltage detection

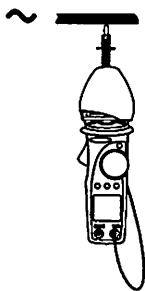

Fig. 19: Voltage detection with rubber cup

1. Select "Ω" position.
2. Insert the red plug into V/Ω jack.
3. Connect the red terminal to the L1 phase conductor (see Fig. 18, 1st measurement). If necessary, use the rubber cup to insert red test lead (see Fig. 19, 1st measurement).
4. When an input voltage greater than 80V is detected, the buzzer emits a sound and symbol "PH" is shown on the main display.

WARNING



During this measurement:

- The instrument must be held in the operator's hand.
- The test lead cable must not be in contact with or near to any voltage source that, due to instrument sensitivity may abort the measurement.

WARNING



- The detected voltage is NOT the phase to neutral voltage, but the voltage between the conductor and the operator who is holding the instrument. This value can be lower than the phase to neutral voltage. **DON'T TOUCH THE PHASE CABLE IF YOU AREN'T SURE THAT ANY VOLTAGE IS PRESENT.**

- If the operator is insulated from the ground (e.g. insulated floors, shoes with rubber soles, etc.), the instrument may not measure correctly. We recommend to repeat test at least twice due to verify the rightness of the obtained result.

5. MAINTENANCE

5.1. GENERAL INFORMATION

1. This digital clamp meter is a precision instrument. Whether in use or in storage, please do not operate to exceed the specifications, avoid any possible damage or danger during use.
2. Do not place this meter in high temperature and/or humidity or expose to direct sunlight.
3. Be sure to turn the meter off after use. For long term storage, remove the batteries to avoid leakage of battery fluid that may damage the internal components.

5.2. BATTERY REPLACEMENT

When the LCD displays the  symbol, replace the batteries immediately:



WARNING

Only experts and trained technicians should perform this operation. Remove the test leads or the circuit under test before replacing the batteries.

1. Turn the rotary switch to the OFF position.
2. Disconnect the test leads from the jacks and any cable from the jaws.
3. Unscrew the battery cover screw and remove the cover.
4. Pay attention to the correct polarity to replace the batteries with two new AAA batteries..
5. Screw the battery cover.

5.3. CLEANING

To clean the instrument, use a soft dry cloth. Never use a wet cloth, solvents or water, etc.

TECHNICAL SPECIFICATIONS

This product conforms to the prescriptions of the European directive on low voltage 73/23/EEC (LVD) and to EMC directive 89/336/EEC, amended by 93/68/EEC.

5.4. CHARACTERISTICS

Accuracy is indicated as [% of reading + digit number]. It is referred to the following reference conditions: 23°C ± 5°C with RH <75%.

DC Voltage

| Range | Resolution | Accuracy | Input impedance |
|------------|------------|---------------------|-----------------|
| 0 - 599.9V | 0.1V | ±(1.0% rdg + 3 dgt) | 1MΩ |

AC Voltage (TRMS)

| Range | Resolution | Accuracy | | Input impedance |
|--------------|------------|-------------------|---------------------|-----------------|
| | | 40 - 200Hz | 200 - 400Hz | |
| 1.6 - 599.9V | 0.1V | ±(1.0% rdg+3 dgt) | ±(5.0% rdg + 3 dgt) | 1MΩ |

Max. Crest factor = 1.41

MAX / MIN / AVG / PEAK AC/DC Voltage

| Function | Range | Resolution | Accuracy | Response time |
|-------------|-------------|------------|----------------------|---------------|
| MAX,MIN,AVG | 10 + 599.9V | 0.1V | ±(5.0% rdg + 10 dgt) | 500ms |
| PEAK | 10 + 850V | 1V | ±(5.0% rdg + 10 dgt) | 1ms |

AC Current (TRMS)

| Range | Resolution | Accuracy | | Overload protection |
|--------------|------------|-------------------|---------------------|---------------------|
| | | 40 + 200Hz | 200 + 400Hz | |
| 0.0 - 399.9A | 0.1A | ±(1.0% rdg+3 dgt) | ±(5.0% rdg + 5 dgt) | 600A RMS |

Max. Crest factor = 2

MAX / MIN / AVG / PEAK AC Current

| Function | Range | Resolution | Accuracy | Response time |
|---------------|--------------|------------|---|---------------|
| MAX, MIN, AVG | 1.0 - 399.9A | 0.1A | $\pm(5.0\% \text{ rdg} + 10 \text{ dgt})$ | 500ms |
| PEAK | 10 - 800A | 1A | $\pm(5.0\% \text{ rdg} + 10 \text{ dgt})$ | 15ms |

Resistance and Continuity test

| Range | Resolution | Accuracy | Overload protection |
|----------------------|--------------|--|---------------------|
| 0.0 - 499.9 Ω | 0.1 Ω | $\pm(1.0\% \text{ rdg} + 5 \text{ dgt})$ | 600V AC/DC RMS |
| 500 - 999 Ω | 1 Ω | | |
| 1000 - 1999 Ω | 3 Ω | | |

Instrument emits a buzzer for R<40 Ω **Frequency (with test leads/ with jaws)**

| Range | Resolution | Accuracy | Overload protection |
|----------------|------------|--|---------------------|
| 40.0 - 399.9Hz | 0.1Hz | $\pm(0.5\% \text{ rdg} + 1 \text{ dgt})$ | 600V RMS / 600A RMS |

Voltage range for frequency measure, with test leads: 0.5 - 600V, with jaws: 0.5 - 400V

Voltage and current harmonics

| Harmonic order | Resolution [V], [A] | Accuracy |
|----------------|---------------------|---|
| 1 - 15 | 0.1 | $\pm(10.0\% \text{ rdg} + 5 \text{ dgt})$ |
| 16 - 25 | 0.1 | $\pm(15.0\% \text{ rdg} + 5 \text{ dgt})$ |

Accuracy defined for: voltage $\geq 1.6V$, current $\geq 2A$ **Power factor**

| Range | Resolution | Accuracy |
|-------------|------------|---------------|
| 0.20 - 1.00 | 0.01 | $\pm 3^\circ$ |

Accuracy defined for: sine wave, voltage 230 - 400V, current $\geq 2A$, freq. 50-60Hz**Active power, Reactive power, Apparent power**

| Range [kW], [kVAR], [kVA] | Resolution [kW], [kVAR], [kVA] | Accuracy |
|---------------------------|--------------------------------|--|
| 0.00 - 99.99 | 0.01 | $\pm(3.5\% \text{ rdg} + 3 \text{ dgt})$ |
| 100.0 - 999.9 | 0.1 | |

Accuracy defined for: sine wave, voltage 230 - 400V, current $\geq 1A$, freq. 50-60Hz, PF: 0.6 - 0.9c**Phase sequence and phase coincidence**

| Range | Frequency range | Input Impedance | Overload protection |
|-----------|-----------------|-----------------|---------------------|
| 50 - 600V | 40 - 60Hz | 1M Ω | 600V RMS |

AX / MIN / AVG Resistance and Continuity test

| Range | Resolution | Accuracy | Tempo di risposta |
|----------------------|--------------|--|-------------------|
| 0.0 - 499.9 Ω | 0.1 Ω | $\pm(1.0\% \text{ rdg} + 5 \text{ dgt})$ | 1s |
| 500 - 999 Ω | 1 Ω | | |
| 1000 - 1999 Ω | 3 Ω | | |

Instrument emits a buzzer for R<40 Ω **MAX / MIN / AVG Frequency (with test leads/ with jaws)**

| Range | Resolution | Accuracy | Tempo di risposta |
|----------------|------------|--|-------------------|
| 40.0 - 399.9Hz | 0.1Hz | $\pm(0.5\% \text{ rdg} + 1 \text{ dgt})$ | 1s |

Max $\Delta f/f \leq 0.5\%$ **MAX / MIN / AVG Active power, Reactive power, Apparent power**

| Range [kW], [kVAR], [kVA] | Resolution [kW], [kVAR], [kVA] | Accuracy | Tempo di risposta |
|---------------------------|--------------------------------|--|-------------------|
| 0.1 - 99.99 | 0.01 | $\pm(3.5\% \text{ rdg} + 3 \text{ dgt})$ | 1s |
| 100.0 - 999.9 | 0.1 | | |

Accuracy defined for: sine wave, voltage 230 - 400V, current $\geq 1A$, freq. 50-60Hz, PF: 0.6 - 0.9c**MAX / MIN / AVG Power factor**

| Range | Resolution | Accuracy | Response time |
|-------------|------------|---------------|---------------|
| 0.20 - 1.00 | 0.01 | $\pm 3^\circ$ | 1s |

Accuracy defined for: sine wave, voltage 230 - 400V, current $\geq 2A$, freq. 50-60Hz**5.4.1. Safety standards**

| | |
|-----------------------------|---|
| Comply with: | EN 61010 |
| Insulation: | Class 2, double reinforced insulation |
| Pollution: | Level 2 |
| For inside use, max height: | 2000mm |
| Over voltage: | CAT III 600V between terminals and ground |

5.4.2. General data

Mechanical characteristics

| | |
|-----------------------------|-------------------------------|
| Size: | 205 (L) x 64 (W) x 39 (D) mm |
| Weight (including battery): | About 280g batteries included |
| Jaws opening: | 30mm |
| Max conductor size: | 30mm |

Power supply

Battery type: 2 batteries 1.5V LR03 AAA.

Low battery indication: Symbol  is displayed when battery level is too low.

Battery life: About 90 hours of continue measurement

Display

Characteristics: LCD with maximum reading 9999 units plus decimal point and sign

Sample rate: 64 samples in 20ms

Conversion mode: TRMS

5.5. ENVIRONMENTAL CONDITIONS

5.5.1. Climatic conditions

| | |
|------------------------|-------------|
| Reference temperature: | 23 ± 5°C |
| Operating temperature: | 5 - 40 °C |
| Operating humidity: | <80% RH |
| Storage temperature: | -10 - 60 °C |
| Storage humidity: | <80% RH |

5.5.2. EMC

This apparatus was designed in accordance with EMC standards in force and its compatibility has been tested in accordance EN61326 (1997) + A1 (1998) + A2 (2001).

5.6. ACCESSORIES

The package contains the following:

- Instrument
- Couple of test leads
- Couple of alligator clips
- Rubber cup for test lead holder
- Certificate of calibration
- Operation manual
- Bag
- Batteries

6. SERVICE

This equipment is guaranteed against any material fault or manufacturer's defect, in accordance with the general conditions of sale. During the warranty period (one year), faulty parts may be replaced, with the manufacturer reserving the right to decide either to repair or replace the product.

In the event of returning the equipment to the after-sales service or to a regional branch, the outward transport is payable by the customer. The delivery must be agreed in advance with consignee.

For delivery indicate by means a note enclosed with the equipment, as clear as possible, the reasons for returning it use only the original packing.

Any damaging caused by shipment using NOT original packaging will be charged in any case to the consignor.

7. APPENDIX VOLTAGE AND CURRENT HARMONICS

7.1. THEORY

Any periodical non-sine wave can be represented as a sum of sinusoidal waveforms each having a frequency that corresponds to an integer multiple of the fundamental frequency, according to the relation:

$$v(t) = V_0 + \sum_{k=1}^{\infty} V_k \sin(\omega_k t + \varphi_k) \quad (1)$$

where:

V_0 = Average value of $v(t)$

V_1 = Amplitude of the fundamental of $v(t)$

V_k = Amplitude of the k^{th} harmonic of $v(t)$

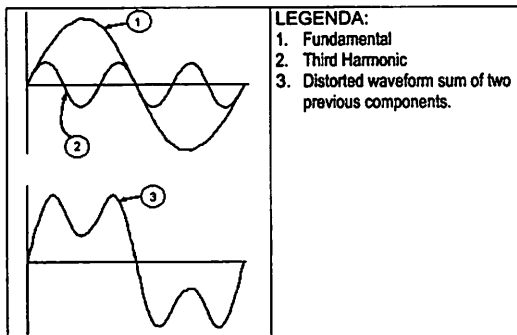

Effect of the sum of 2 multiple frequencies.

In the mains voltage, the fundamental has a frequency of 60 Hz, the second harmonic has a frequency of 120 Hz, the third harmonic has a frequency of 180 Hz and so on. Harmonic distortion is a constant problem and should not be confused with short durations events such as sags, surges or spikes.

It can be noted that in (1) the index of sigma is from 1 to the infinity. What happens in reality is that a signal does not have an unlimited number of harmonics: a number always exists after which the harmonics value is negligible. The EN 50160 standard recommends the index end in (2) in correspondence of the 40th harmonic.

A fundamental element to detect the presence of harmonics is THD defined as:

$$THD_v = \frac{\sqrt{\sum_{h=2}^{40} V_h^2}}{V_1}$$

This index takes all the harmonics into account. The larger it is, the more distorted the waveform gets.

7.2. LIMIT VALUES FOR HARMONICS

EN-50160 fixes the limits for the harmonic voltages, which can be introduced into the network by the energy provider. Under normal conditions, during whatever period of a week, 95% of the RMS value of each harmonic voltage, for a duration of 10 minutes, will have to be less than or equal to the values stated in the following table.

The total harmonic distortion (THD) of the supply voltage (including all the harmonics up to the 40th order) must be less than or equal to 8%.

| Odd harmonics | | | | Even harmonics | |
|-------------------|------------------------|---------------|------------------------|----------------|-----------------------|
| Not multiple of 3 | | Multiple of 3 | | Order h | Relative voltage %Max |
| Order h | Relative voltage % Max | Order h | Relative voltage % Max | | |
| 5 | 6 | 3 | 5 | 2 | 2 |
| 7 | 5 | 9 | 1,5 | 4 | 1 |
| 11 | 3,5 | 15 | 0,5 | 6.24 | 0,5 |
| 13 | 3 | 21 | 0,5 | | |
| 17 | 2 | | | | |
| 19 | 1,5 | | | | |
| 23 | 1,5 | | | | |
| 25 | 1,5 | | | | |

These limits, theoretically applicable only for the supplier of electric energy, provide however a series of reference values within which the harmonics introduced into the network by the user must be contained.

7.3. CAUSES FOR THE PRESENCE OF HARMONICS

Any apparatus that alters the sine wave or uses only a part of such a wave causes distortions to the sine wave and therefore harmonics.

All current signals result in some way virtually distorted. The most common situation is the harmonic distortion caused by non-linear loads such as electric household appliances, personal computers or motor speed control drives. Harmonic distortion causes significant currents at frequencies that are odd multiples of the fundamental frequency. Harmonic currents affect the neutral current.

In most countries, the mains power is three-phase 50/60Hz with a delta primary and star secondary transformers. The secondary generally provides 230V AC from phase to neutral and 400V AC from phase to phase. Balancing the loads on each phase has always represented a headache for electric systems designers.

Until some ten years ago, in a well balanced system, the vector sum of the currents in the neutral was zero or quite low (given the difficulty of obtaining a perfect balance). The devices were incandescent lights, small motors and other devices that presented linear loads. The result was an essentially sinusoidal current in each phase and a low current on the neutral at a frequency of 50/60Hz.

"Modern" devices such as TV sets, fluorescent lights, video machines and microwave ovens normally draw current for only a fraction of each cycle thus causing non-linear loads and subsequent non-linear currents. All this generates odd harmonics of the 50/60Hz line frequency. For this reason, the current in the transformers of the distribution boxes

contains only a 50Hz (or 60Hz) component but also a 150Hz (or 180Hz) component, a 50Hz (or 300Hz) component and other significant components of harmonic up to 750Hz (or 900Hz) and higher.

The vector sum of the currents in a well balanced system that feeds non-linear loads may still be quite low. However, the sum does not eliminate all current harmonics. The odd multiples of the third harmonic (called "TRIPLENS") are added together in the neutral conductor and can cause overheating even with balanced loads.

7.4. CONSEQUENCES OF THE PRESENCE OF HARMONICS

In general, even harmonics, i.e. the 2nd, 4th etc., do not cause problems.

Designers should take into consideration the following points when designing a power distribution system that will contain harmonic current:

| Installation parts | Effects attributed to Harmonics |
|-----------------------|--|
| Fuses | Heating of internal fuse elements. This over-heating can cause an explosion of the fuse casing. |
| Cables | Increase in "body" effect. This means, for cables with many wires, the internal wires have higher impedance than external wires due to their inability to dissipate heat. The consequence of this is the current, which normally is distribute along the external surface of wire, produces: <ul style="list-style-type: none"> - an over-heating of the conductor; - a premature degrading of the cable's insulation; - an increase in line voltage drop. |
| Neutral conductor | The triplens harmonics, odd multiples of three, sum on the neutral conductor (instead of erasing themselves) and generate a potential danger over-heating situation of the same conductor. |
| Transformer | Increasing of copper loss due to a higher TRMS current value that circulate on internal circuits and due to "body" effect present on protected wires also. Increasing of iron loss due to hysteresis cycle distortion and due to generation of leakage currents on magnetic core. Heating of insulation material due to eventually DC component that can generate saturation of magnetic core column. |
| Motors | Increase of loss due to over-heating of internal circuits and possible damage of insulation material. Increase in motor vibration reducing efficiency and causing premature motor wear. The 5 th and 11 th harmonic components generate some abnormal electromagnetic coupling that can increase motor speed. |
| Re-phased capacitance | Increase in "parallel resonance" present inside a circuit, due to inductive loads and re-phased capacitance, when at least one of the harmonics has the same frequency as the resonance phenomenon. Effects of this event can be very dangerous. with explosion of used re-phased capacitances. |
| RCD devices | Possible saturation of current sensing toroidal transducers resulting in incorrect measurements. |
| Energy disk counters | Increased rotation speed of a disk resulting in measurement error (especially in cases of low power factor loads). |
| Power controls switch | Reduce of electrical duration of contact surfaces. |
| UPS | Reduced power generation from UPS. |
| Electronics devices | Internal damage of electronic components. |



V201011