

Instructions for the 16A2 & 16A3 Series Microprocessor Based Temperature / Process Control



CONTENTS

GETTING STARTED	2
MODEL IDENTIFICATION	3
INSTALLATION	4
WIRING	5
Wiring for 4 to 20mA Transmitter Inputs	6
Wiring for Optional Inputs and Outputs	6
FRONT PANEL KEY FUNCTIONS	8
Security Level Selection	9
NOTATION CONVENTIONS FOR THE MENUS	10
THE HOME DISPLAY	11
Programming and Operation for Ramp / Soak Feature (16A3 Only)	11
Theory of Operation	11
Program Setup	12
Ramp / Soak Operation	13
AUTO / MANUAL OPERATION (16A3 ONLY)	15
Operation Self Tune Function	16
Theory of Programming	16
Program Setup and Operation	16
OPERATION AND PROGRAMMING OF OPTIONS	17
MENU SELECTIONS	20
PRIMARY MENU	20
SECONDARY MENU	20
SECURE MENU	28
ALARM TYPE AND ACTION	33
ERROR MESSAGES	37-39
SPECIFICATIONS	40
DIMENSIONS	44

GETTING STARTED

1. Install the control as described on page 4.
2. Wire your control following the instructions on page 5. If you are using a two-wire transmitter as an input, see the drawing and instructions on page 6. Option wiring instructions are on Page 7. Option descriptions and specific instructions start on page 13.
3. Most controls do not need many (if any) program changes to work on your process. For best results when changing the programming, make all the necessary changes in the Secure Menu (page 28) before making changes to the Secondary Menu (page 20). If error messages occur, check the Error Messages on page 37-39 for help.

Take the example of a Model 16A3010 that comes from the factory programmed for type J thermocouples. Suppose for this example you wish to change the input to a 100 ohm Platinum RTD and limit the set point range between 0° and 300°C.

First enter the Secure menu by pressing and holding the   **UP ARROW** &

ENTER keys for 5 Seconds (see Page 28.) Press the **INDEX** key until the display shows *inP* and press the **DOWN ARROW** until the display shows *P385*. Don't forget to press the **ENTER** key to retain your setting.

Next, press the **INDEX** key to display *Unit*. Press the **DOWN ARROW** until the display shows *ℓ*. Press **ENTER**.

Next, press the **INDEX** key until *SPL* is displayed (pass the *dPt* and *inPt* selections). Press the **UP ARROW** until the display shows *0*. Press **ENTER**.

Finally, press **INDEX** key to display *SPH*. Press the **DOWN ARROW** until the display shows *300*. Press **ENTER**.

The necessary program changes are now complete. After 30 seconds the display will switch back to the temperature reading. If you want to return faster, press the **UP ARROW** and **ENTER** keys (at the same time) and then press the **DOWN ARROW** and **INDEX** keys (again at the same time). This will 'back out' of the menu and immediately display the temperature reading.

If you want to use Self Tune or Auto/Manual features, see the special sections on these items. Page numbers for these are in the Contents section on the previous page.

MODEL IDENTIFICATION

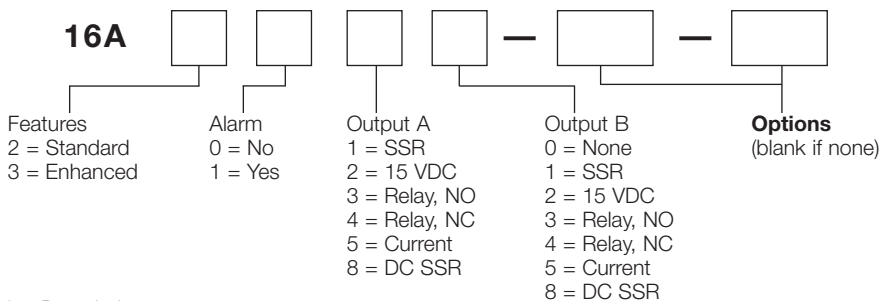

Option Description

- 992* RS-485 Serial Communications, Lovelink™ protocol.
- 993* RS-232 Serial Communications, Lovelink™ protocol.
- 995* RS-232 Serial Communications, Modbus™ protocol.
- 996* RS-485 Serial Communications, Modbus™ protocol.
- 9502 12-24 Vdc/Vac 50-400 Hz power supply (control operates on low voltage equipment).

* These options may not be combined with each other. Option 9502 may be combined with any other options.

INSTALLATION

Mount the instrument in a location that will not be subject to excessive temperature, shock, or vibration. All models are designed for mounting in an enclosed panel.

Select the position desired for the instrument on the panel. If more than one instrument is required, maintain the minimum of spacing requirements as shown on the drawing below. Closer spacing will structurally weaken the panel, and invalidate the IP66, UL type 4X rating of the panel.

Prepare the panel by cutting and deburring the required opening.

All Tolerances are $-0.00 +0.60\text{mm}$ ($-0.000 + 0.020$ in.)

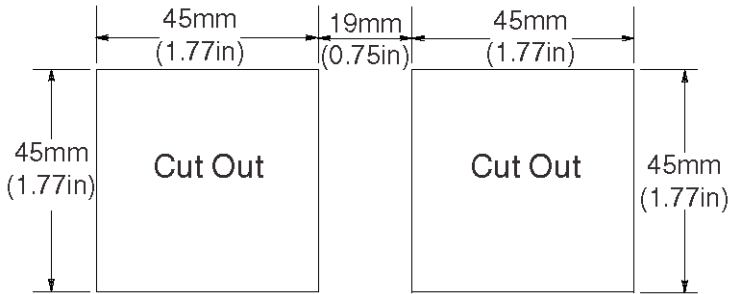

From the front of the panel, slide the housing through the cut out. The housing gasket should be against the housing flange before installing.

From the rear of the panel slide the mounting collar over the housing. Hold the housing with one hand and using the other hand, push the collar evenly against the panel until the spring loops are slightly compressed. The ratchets will hold the mounting collar and housing in place.

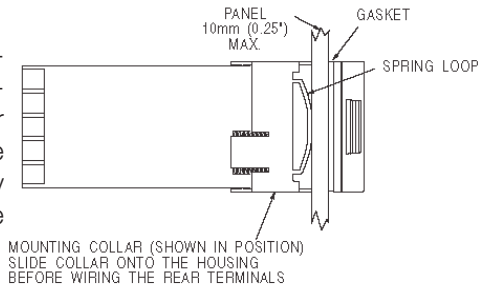

CAUTION: It is not necessary to remove the instrument chassis from the housing for installation. If the instrument chassis is removed from the housing, you must follow industry standard practice for control and protection against Electro-Static Discharge (ESD). Failure to exercise good ESD practices may cause damage to the instrument.

WIRING



Do not run RTD, thermocouple, or other class 2 wiring in the same conduit as power leads. Use only the type of thermocouple or RTD probe for which the control has been programmed. Maintain separation between wiring of sensor, optional inputs and outputs and other wiring. See the “Secure Menu” for input selection.

For thermocouple inputs always use extension leads of the same type designated for your thermocouple.

For supply connections use No. 16 AWG or larger wires rated for at least 75°C. Use copper conductors only. All line voltage output circuits must have a common disconnect and be connected to the same pole of the connect.

Input wiring for thermocouple, current, and RTD; and output wiring for current and 15 VDC is rated CLASS 2.

Control wiring is as shown (view is from the rear of instrument showing wiring terminals).

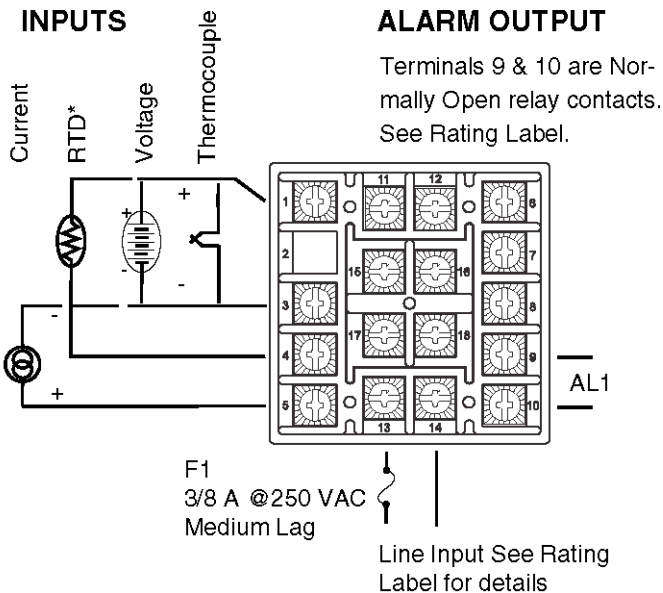

*For 2 wire 100 Ohm and 1K Ohm RTD use terminal 1 & 3, and place a jumper wire between terminals 3 & 4.

OUTPUTS

(Rear View showing center block of wiring terminals.)

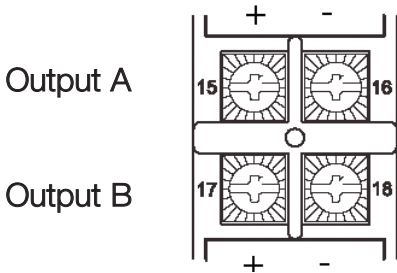

For AC SSR or relay type outputs (Output Codes 1 or 3), 15 & 16, and 17 & 18 are normally open. See Rating Label for details.

For Pulsed DC, Current, or DC SSR outputs (Output codes 2, 4, or 8), 15 & 17 are positive, 16 & 18 are negative.

Note: Factory default assigns Output A to Set Point 1 and Output B to Set Point 2. If necessary, these relationships may be reversed. See **SP 10** in the Secure Menu.

Wiring for 4 to 20mA Transmitter Inputs

Wiring power and outputs as shown above. Two-wire transmitters wire as shown below. View is of instrument as seen from the rear to show wiring terminals. For three or four-wire transmitters, follow the wiring instructions provided with your transmitter.



CAUTION: DO NOT WIRE THE 24 VOLT POWER SUPPLY ACROSS THE INPUT OF THE CONTROL. DAMAGE TO THE CONTROL INPUT CIRCUITRY WILL OCCUR.

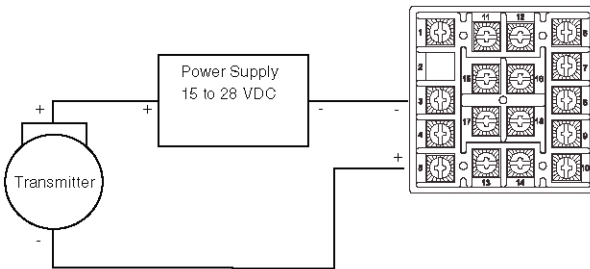

Wiring for Optional Inputs and Outputs

Options are described on Page 3. Detailed option programming and operation starts on Page 13. Wire power and outputs as shown on Pages 5 and 6. Wiring for options is shown opposite. All wiring shown above is CLASS 2. Shielded twisted pair is required for Options 992 and 994. Shielded cable is required for Options 993 and 995.



CAUTION: DO NOT RUN SIGNAL WIRING IN THE SAME CONDUIT OR CHASE AS THE POWER WIRING. ERRATIC OPERATION OR DAMAGE TO THE CONTROL CIRCUITRY WILL OCCUR.

OPTION/TERMINALS	11	12	6	7	8
PV1 PV/SV Retransmission, Current (e.g. 4-20 mA)	+	-	na	na	na
PV2 PV/SV Retransmission, Voltage (e.g. 0-10V)	+	-	na	na	na
992, 996 RS-485 Serial Communications	B	A	na	na	na
993, 995 RS-232 Serial Communications	Data In	Data Out	Signal Ground	na	na

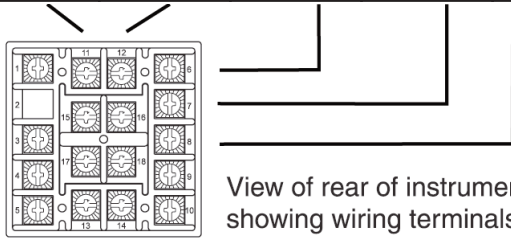

View of rear of instrument showing wiring terminals.

RS-485 Daisy Chain Wiring Example

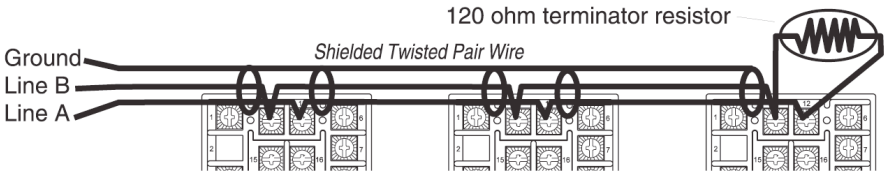

Note: Industry standard designation for RS-485 lines is A and B. Some equipment manufacturers use a non-standard designation of plus and minus. The association of A to minus and B to plus is based on a sample of devices marked as plus and minus and is not intended to represent ALL such labelled devices. Final responsibility for correct identification of leads and terminals rests with the user/installer and the manufacturer of the other device(s) installed in the system.

RS-232 DB-25 WIRING (VIEWED FROM WIRE SIDE)

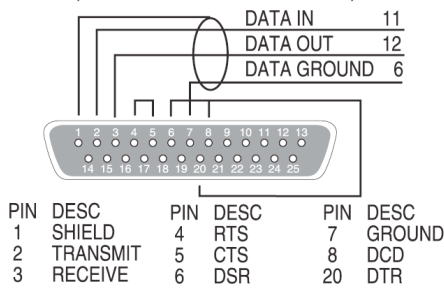

RS-232 DB-9 WIRING (VIEWED FROM WIRE SIDE)

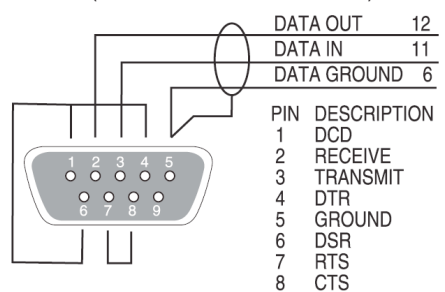



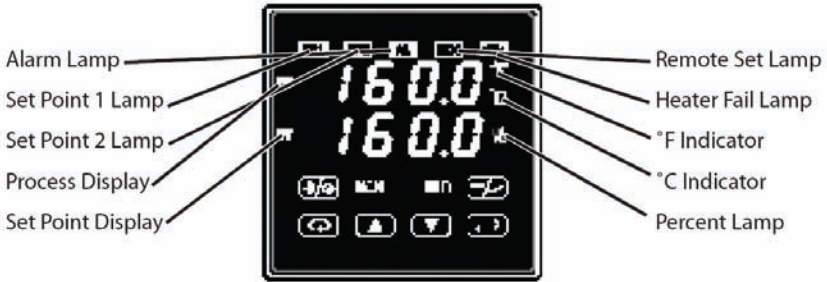









FRONT PANEL KEY FUNCTIONS



The decimal point flashes when Self Tune is operating.

Keys are illuminated when pressed. Key functions are as follows:

-  **INDEX:** Menu Navigation. Pressing the  INDEX key advances the display to the next menu item. May also be used in conjunction with other keys as noted below.
-  **UP ARROW:** Increments a value, changes a menu item, or selects the item to ON. The maximum value obtainable is 9999 regardless of decimal point placement.
-  **DOWN ARROW:** Decrements a value, changes a menu item, or selects the item to OFF. The minimum value obtainable is -1999 regardless of decimal point placement.
-  **ENTER:** Pressing  ENTER stores the value or the item changed. If not pressed, the previously stored value or item will be retained. The display will flash once when  ENTER is pressed.
-  **AUTO/MANUAL (16A3):** This key toggles the control output between Automatic mode and Manual mode. Press and hold key for three seconds to activate. See section on Ramp/Soak (Page 11) for further details.
-  **RUN/HOLD (16A3):** This key toggles the Ramp/Soak program functions between Run mode (program runs as set up), and Hold mode (program functions are suspended). Press and hold key for three seconds to activate. See section on Auto/Manual Operation on page 14.
-  **UP ARROW & ENTER:** Menu Access. Pressing these keys simultaneously brings up the secondary menu starting at the alarm, tune, or cycle item (depending on programming). Pressing these keys for 5 seconds will bring up the secure menu.
-  **INDEX & DOWN ARROW:** Menu navigation. Pressing these keys simultaneously will allow backing up one menu item, or if at the first menu item they will cause the display to return to the primary menu.
-  **INDEX & DOWN ARROW:** Alarm Reset. If an alarm condition has occurred, press and hold these keys for three seconds to reset the alarm. Note that the alarm condition will not reset if the alarm condition still exists.
-  **INDEX & ENTER:** 'Global Reset'. Pressing these keys simultaneously and holding them for 5 seconds forces a 'warm boot', restart-

ing the control (similar to turning power off and on). 'Global Reset' will allow recovery from errors and reset the following menu items:

AL **.H**: Alarm inhibit

OPEn **inP**: Input error



bA **nP**: Input err

CHEC **CAL**: Check calibration



Correct the problems associated with the above conditions before using the reset keys. More than one error could present. Caution is advised since several items are reset at one time.



While in the **Primary** or **Secondary Menu**, if no key is pressed for a period of 30 seconds, the display will return to the HOME position displaying the temperature value. While in the **Secure Menu**, if no key is pressed for a period of 60 seconds, the display will return to HOME position displaying the temperature value. Outputs are disabled (turned off) when the **Secure Menu** is active.

NOTE: To move the **Primary Menu** quickly from any other menu, press the

  **UP ARROW & ENTER** keys followed by pressing the  **INDEX & DOWN ARROW** keys.

SECURITY LEVEL SELECTION

Four levels of security are provided. The display shows the current security level. To change security levels, change the password value using the  **UP ARROW** and  **DOWN ARROW** keys and press the  **ENTER** key. Refer to the password table for the correct value to enter for the security level desired. The **SECr** menu item security level may be viewed or changed at any time regardless of the present security level.

Example: To set security access level to 2, at the **SECr** menu item, press the  **UP ARROW** key until the upper display shows the password for level 2 access, **1101**. Press the  **ENTER** key. The display will blink and return with the level value, 2, in the upper display.

The password values shown in the table cannot be altered, so retain a copy of these pages for reference. This is the only reference made to password values in this instruction book.

PASSWORD TABLE

Security Level		Displaying Value When Viewed	Password Value To Enter
Menu	Status		
Primary	Locked	1	1110
Secondary	Locked		
Secure	Locked		
Primary	Unlocked	2	1101
Secondary	Locked		
Secure	Locked		
Primary	Unlocked	3	1011
Secondary	Unlocked		
Secure	Locked		
Primary	Unlocked	4	111
Secondary	Unlocked		
Secure	Unlocked		

NOTATION CONVENTIONS FOR THE MENUS



Because of the number of features available in this control, information is included that may not apply to your specific control. All usable features are included in this book, but may not be used in your process. To increase clarity, the following conventions are used:

1. Certain features, menu items, and function shown in this book may or may not appear on your control, depending on other menu item selections. At various places in the menus there are notes identifying menu items that “control” or “direct” other menu items. If you are looking for a particular menu item and can’t find it, check the menu item that is its “control” for proper setting
2. The “#” symbol is used in two ways. It is used inside group of characters to indicate which set point function (SP1 or SP2) is being affected. It is also used before a group of characters of a menu item to indicate that there may be more than one selection or value for that menu item. This is used for certain repeated items such as in the Ramp/Soak Program section.
3. *Features that apply only to Options will be printed in Italics.* **Features that apply only to the 16A3 Series will be notated in the Roman serif type.**

THE HOME DISPLAY

The home display is the normal display while the control is operating. If no errors or functions are active, the HOME display will indicate the Process Variable (the temperature, pressure, flow, RH, etc., that is being measured) on the top display and the Set Variable (Set Point 1) on the bottom.

Items that can change the HOME display are the Auto/Manual function, the Run/Hold function, the *PROG* function, the *PCTO* function, and any error message. Description of these special displays follows.

If the  Auto/Manual key is pressed, the Manual indicator lights, and the home display is changed. The upper display continues to show the Process Variable (PV), but the lower display changes to show the percentage of output in tenths of a percent to 99.9% (0.0 to 99.9) or 100 if 100%. The display digit to the right of the number shows a flashing letter *o* to indicate that the value displayed is no longer the SV, but percent output. The *SP2* percent output is indicated by the use of an overline on the *o*. Access to the *SP2* value is made by the  INDEX key. See Auto/ Manual Operation on Page 14 for further information.

If *PROG* is turned *On*, the HOME display changes the SV display from SP1 to the Present Set Variable as calculated by the Ramp/Soak Programmer function. See Programming and Operation for Ramp/Soak Feature below for more information.

If *PCTO* (Secondary Menu) is turned *On*, the lower display changes to show the active percentage of output as required to maintain *SP1*. The display is similar to the Auto/Manual display above, except that the percent indicators (*o*, *o*) do not flash, and the output is displayed in whole percentages of output, not in tenths of a percent. If the control has both *SP1* and *SP2*, the lower display will alternate between the *SP1* percent output and the *SP2* percent output.

Error messages are listed on Pages 37-39.

PROGRAMMING AND OPERATION FOR RAMP / SOAK FEATURE (16A3 ONLY)

The Ramp / Soak feature offers a great deal of flexibility by allowing changes in the set point to be made over a predetermined period of time. Dwell times can be programmed, and the alarm output relay can be programmed to open or close during any of the segments.

Theory of Operation

The 16A3 Series controls offer a very simple approach to programming a ramp. Rather than requiring the operation to calculate an approach rate (usually in degrees per minute), the 16A3 does the calculation internally. Thus, the operator only needs

to program the target set point and the time desired to reach that point. When the ramp segment is executed by the control, it calculates the ramp required to move the process from the starting value (current PV) to the desired value (programmed SP) in the time allowed.

Soaks (or dwells) are ramp segments where the target set point is the same as the beginning process value. This allows for multistage ramps without wasting intermediate soak steps. Care must be taken, however, that the process does actually reach the soak value before the soak time starts. If not, the next segment will calculate a slope from the starting PV to the target SP. Depending on your process requirements, this difference may be important. Make sure to test any program for desired results before running production material.

Do not operate Self Tune while a ramp function is operating. The ramp function will prevent the Self Tune from operating properly. Make sure that all tuning is set up before operating Ramp / Soak.



Program Setup

All of the programming for the Ramp / Soak function is done in the Secondary Menu. You may wish to work out your program on paper before going into the programmer menu sequence.

In the Secondary Menu  INDEX to *Prog* and make sure that *Prog* is set to *OFF*.

 INDEX to *PSet* and turn *On*. Press  ENTER.



Skip the *StRT* setting (this is discussed later) and press  INDEX to *tbRS*.

The time base menu item, *tbRS*, allows selection of the amount of time that is counted per time unit. Setting *tbRS* to *1* makes all time settings use a time base of one second. A *tbRS* setting of *60* makes all times settings use a time base of 60 seconds, or one minute. Make the appropriate selection and then press  ENTER  and INDEX to *1t1*.

The following items repeat in the following order: *1t1*, *1SP*, *1R1* (if *AL1* in the Secure Menu is programmed set to *Enable*), *2t1*, *2SP*, *2R1*, . . . , *16t1*, *16SP*, *16R1*. To avoid repetition each item will only be described once.

Set *1t1* to the amount of time you want for the first ramp. This value is in time units (determined by the *tbRS* menu item) from *0* to *9999*. Press  ENTER.

Set *1SP* to the target value desired for the first ramp. This value is in actual units just like *SP 1*. If the control is programmed for temperature, then the SP displays are in temperature. If the control is programmed for some other engineering unit, the SP is set in that unit.

Press  INDEX to continue. If Alarm 1 is programmed as an event (*AL 1 = Event*), then *!R 1* will appear. If you wish the Alarm 1 contact to function for this segment, set *!R 1* is set to *On*. If not, set for *OFF*. Press  ENTER. When *!R 1* is set *On*, the Alarm 1 function will be active for entire period set *!t* above.





Complete setting the segment times (*2t . . . 16t*), segment set point (*2SP . . . 16SP*), and event alarms (*2R 1 . . . 16R 1*) to *On* or *OFF*.

For unneeded or unused segments set the segment times (*2t . . . 16t*) to *0*, and set the segment set point (*2SP . . . 16SP*) to the same value as the last active set point. A segment alarm may be set to indicate "end of run" at the segment number you select.

The last menu item for the ramp / soak function is *PEnd*. *PEnd* determines what the control does when the program has ended. You may choose to have the program repeat (*Loop*), *Hold* the last set point (*16SP*), revert to the local *SP 1*, or turn the outputs off (*OFF*).

It is important to remember that if you want the program to repeat, you must allow the process to return to the same condition that existed when the program first started. Remember that the ramp function calculates the slope by drawing a line from the beginning PV to the ramp target set point. If the PV at the end of the program is different than the PV at the initial start, the ramp will calculate differently.

Ramp / Soak Operation

When you wish to start the program, enter the Secondary Menu and set the *Prog* menu item on *On*. Return to the HOME position by waiting for the display to time out or by pressing the   UP ARROW & ENTER keys and then the   DOWN ARROW & INDEX keys.

The home display will read as it normally does. The HOLD indicator by the RUN / HOLD key will be lit. To start the program press the  RUN / HOLD key for three seconds. The HOLD indicator will go out, and the program will start.

To suspend the program at any time, press the  RUN / HOLD key. Press the key again to resume.



Pressing the  AUTO / MANUAL key will also suspend the program operation. The difference is that AUTO / MANUAL also puts the control into manual mode. See Auto / Manual operation on page 14.

The function of the Primary Menu will change depending on the setting of the **SEAL** menu item in the Secondary Menu. If **SEAL** is **OFF** then the Primary Menu is not changed.

If the **SEAL** menu item is set **ON**, then the Primary Menu has three additional information items added before **SP** appears. The first INDEX item displays the time remaining in the current segment in the top display (####), and the message **EL**, in the lower display. The next INDEX item displays the total time for the active segment in the upper display (####) and the message **##EL (EL . . . !SEL)**, in the lower display. The third INDEX item displays the segment set value (####) in the top display, and the message **##SP (!SP . . . !SSP)** in the lower display. The next INDEX press resumes the normal Primary Menu.

AUTO / MANUAL OPERATION (16A3 ONLY)

The AUTO / MANUAL function allows you to manually adjust the output of the control. This is normally used during process setup or start up. It can also be used for troubleshooting. To switch from AUTO to MANUAL press the  AUTO / MANUAL key and hold for three seconds. The MANual indicator will light and the lower display will change from normal to showing the actual output in percent. The value will be the actual percentage of output that was active when the key was pressed. This is usually known as “bumpless transfer”.

If you wish to change the output while in manual, press the  UP ARROW or  DOWN ARROW keys to change the value, and press  ENTER to retain it. It is important to remember that the value of the display can be read as 0 to 100% of the full control output, or 0 to 100% of the range between $S\ 10L$ and $S\ 10H$ or $S20L$ and $S20H$. If $RPCE$ is set for $REAL$, a reading of 50% in MANUAL represents 10 mA (Assuming a current output regardless of the $S\ 10L$ and $S\ 10H$ settings.) If $RPCE$ is set for Adj , then 50% in MANUAL will represent the mid point in output between $S\ 10L$ and $S\ 10H$. (Assuming a current output, 4 to 20 mA, with $S\ 10L$ set to 20 and $S\ 10H$ set to 100 , 50% will represent 12 mA.)

To return to AUTOMATIC control, press the  AUTO / MANUAL key again. The MANual indicator will go out, and the set point will take over. However, if you want bumpless transfer back to AUTO, slowly change the percentage of output until the process variable matches (or at least is close) to the set point. The further away the PV is from the set point, the greater the “bump” or upset there will be in the output.

Operating of Self Tune Function

Self Tune allows automatic selection of the necessary parameters to achieve best control operation from your 16A2 & 16A3 Series control. If you are using the control output as a simple on-off function (**Output** is set for **ONOFF**), none of the following will apply.

Theory of Operation

The Self Tune function calculates the **Pb**, **rES**, and **rEE** parameters under the **Self Tune** selection, and the **Fbnd** and **FrtE** parameters, as shown in the Secondary Menu. These values are determined by measuring the response of the process connection to the control. While in this mode the control measures the overshoot and undershoot of the process, and the period of the process (the time from peak value to the next peak value). These measurements are collected over a period that lasts three periods of overshoot and undershoot. The data collected over this time is effect of Fuzzy Logic on the process is still controlled by the **Fint** (fuzzy intensity) setting. If **Fint** is **0**, the **Fbnd** and **FrtE** will be calculated, but will have no effect. The calculations for the PID values are the same as used in the standard Ziegler - Nichols equations that have been recognized as standard for decades.

The only modification to the application of the Ziegler - Nichols equations is controlled by the **dFRC** menu item. This menu item controls the amount of rate (derivative) that is applied. A **dFRC** setting of 3 (factory default) or less allows for less damping. A **dFRC** setting of 4 allows for critical damping as set forth in Ziegler - Nichols. A **dFRC** setting of 5 or more allows over damping of the process.

Program Setup and Operation

Do not cool the process or add heat while the tuning is occurring. In the secondary menu set **Self Tune** to **SELF**. Skip **LErn** and check to make sure that **dFRC** is set to the desired value. Back up to **LErn** and set to **YES**. The control will begin the Self Tune function. While the Self Tune function is active, the right hand decimal point on the lower display will blink. When Self Tune is complete, the blinking will stop.

After Self Tune is complete, the **Self Tune** setting automatic switches to **PID**. This allows examination and/or modification of the values calculated. We recommended that you do not change the calculated values unless you have a firm understanding of the parameters involved and their function.

OPERATION AND PROGRAMMING OF OPTIONS

Option 992, 993, 995, 996 Serial Communication

The serial communications options allow the control to be written to and read from a remote computer or other similar digital device. Communication is allowed either through a RS-485 (Option 992, 996) port, or a RS-232 (Option 993, 995) port.

Wire the communication lines as shown on Page 7. Wiring for the RS-485 is run from control to control in a daisy chain fashion with a termination resistor (120 ohms) across the transmit and receive terminals of the last control in the chain.

Select the control address and communication baud rate with the *Addr* and *BAUD* menu items in the Secure Menu.

NOTE: THE BAUD RATE AND ADDRESS MENU ITEM SETTINGS WILL TAKE EFFECT ON THE NEXT POWER UP OF THE CONTROL. BE SURE TO TURN THE POWER TO THE CONTROL OFF AND ON BEFORE USING THE NEW BAUD RATE AND ADDRESS VALUES.

In operation, you have the option of preventing a write command from the host computer. To prevent the host from writing to the control change the *LGRE* menu item in the Secondary Menu to *LOC*. To allow the host to write commands to the control set *LGRE* to *RE*. (The host does have the ability to change the *LGRE* state, but it is not automatic.)

If your system depends on constant reading or writing to and from the host, you may wish to set the No Activity Timer (*NAE*) to monitor the addressing of the control. When the *LGRE* is set to *RE* and the *NAE* is set to any value other than Off, the control will expect to be addressed on a regular basis. If the control is not addressed in the time set by the value of *NAE*, then the control will display the error message *CHEC LGRE*. To clear the message set *LGRE* to *LOC*.

Serial Communications Options and Non-volatile Memory

There are many different types of memory used in computer driven devices. The terms RAM (random access memory) and ROM (read only memory) are a couple with which you may be familiar.

RAM is used in computers to run programs and hold data for a short period of time. This is the memory that is used primarily in PCs. RAM is very fast and can be read and written to over and over again.

ROM is used in computers to hold the 'permanent' programming that allows a PC to start. This memory is 'burned in' to the chip itself and can not be changed. Unlike RAM, however, this memory is permanent. While it can not be changed, it can not lose its programming when power is turned off.

There is a third type of memory that is now currently used to combine the characteristics of both RAM and ROM. This is known as EEPROM (electrically erasable programmable read only memory). While the name may be long and somewhat cryptic, the EEPROM can be erased and re-written many times, and yet hold the programmed data even over long periods of time when the power is off. This is the type of memory that all Love Controls uses to save the settings your program in your control. The reliability and longevity of the data retention is what allows us to guarantee a 10 year data retention without power.

In normal operation, the control uses RAM, just as any other computerized device. Whenever you make a change to one of the parameters in the control, the set point for example, the new value is written into the EEPROM. This way, if power goes off for whatever reason, when power resumes, the latest settings are preserved. When power is turned on, the data is copied from the EEPROM to the RAM to begin operation.

If EEPROM is such a wonderful thing, you might ask, why bother with RAM? One reason is that RAM is much faster than EEPROM. Faster speed gives you better performance in critical control functions.

Perhaps the most important reason is that EEPROM has a limit to the number of times it can be erased and re-written. Current technology now sets that limit at about one million erase/write cycles. In a dynamic control situation, it may be necessary to update RAM every few milliseconds. EEPROM can not keep up to that pace, and, even if it could, it would be 'used up' in a matter of days.

If you think about how long it would take a million changes to the control programming through the front key pad, you will see that it would take a very long time to get to use up the life of the EEPROM.

Adding one of the computer communications options (e.g. 992, 993) changes the picture. The speed of computer communications is such that hundreds of instructions can be made in less than a minute. In such a situation, the million erase/write cycles could be used up in a couple of months causing the control to fail.

Usually in such a situation, the control is under close observation by the host computer. It may not be necessary, then to the data written to the EEPROM, as it is 'transitory' in nature (changing set points for a ramp/soak sequence for example).

All 16A Series controls with communications options made before April 2001 are only able to write to the EEPROM. Controls manufactured after this date have a menu item in the Secure menu (*Stor*) that allows the serial communications to write to RAM (*Stor = ra*) with a special write command that allows to EEPROM to be updated or written directly to EEPROM (protocol command 0442).

The factory default is 'write to EEPROM' (*Stor = YES*).

If your computer system will be making frequent changes to the control we strongly recommend that you select the 'write to RAM' parameters (*Stor = ra*). If you are primarily reading from the control, there is no need to change the setting.



Any instruments equipped with any Serial Communications are limited to one million **WRITE** cycles to the **EEPROM** through the Serial Communications Port. Exceeding this limit will generate a **FAIL TEST** error. There is no limit to the number of times you can **READ** from this instrument EEPROM.

Make sure that the software you use does not write too often to the instrument.

If you have any questions regarding how your software works with the instrument(s), contact your System Administrator, Programmer, or Software Supplier.

MENU SELECTIONS

PRIMARY MENU

Press **INDEX** to advance to the next menu item. Press **UP ARROW** or **DOWN ARROW** to change the value in the display. Press **ENTER** to retain the value. If StAt, (Secondary Menu [16A3]), is **00**, the three program status menu items shown on Page 14 will precede the following.

SP 1 Set Point 1 Adjust, Control Point 1.

SP 2 Set Point 2 Adjust (if equipped), Control Point 2.

SECONDARY MENU

Hold **UP ARROW & ENTER**. Press **INDEX** to advance to the next menu item. Press **UP ARROW** or **DOWN ARROW** to change the value in the display. Press **ENTER** to retain the value.

AL 1 L Alarm 1 Low: The Low Alarm point is usually set below the Set Point. May not appear depending on **AL 1** setting in Secure Menu.

AL 1 H Alarm 1 High: The High Alarm Point is usually set above the Set Point. May not appear depending on **AL 1** setting in Secure Menu.

Out 1 Output selection: Select *OnOff*, *#tP*, *#PUL*, or *Prop*.

OnOff A setting of *OnOff* allows the control to operate in simple on/off mode. This setting forces the control to turn off at set point, and on at the set point plus the differential (*SP Id*). When selected, the **Out 1 OnOff** menu items is followed by ##### *SP Id*, and the *turnE*, *Pb*, *rES*, *S 10L* and *S 10H* selections in the Secure menu are suppressed.

SP Id Set Point On-Off Differential (hysteresis). Set for the amount of difference between the turn off point and the turn on point. Select *I* to *9999* (direct acting), or *- I* to *-9999* (reverse acting). This value will be negative for reverse acting set points, and positive for direct acting outputs. The following drawings shows output behavior for reverse and direct action. For reverse action note how the output decreases as the input process variable increases, e.g. heat power goes to zero as the temperature increases to set point.

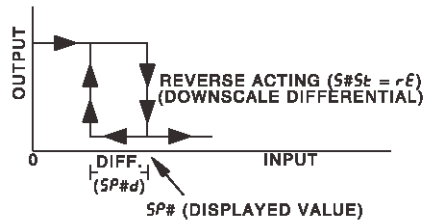
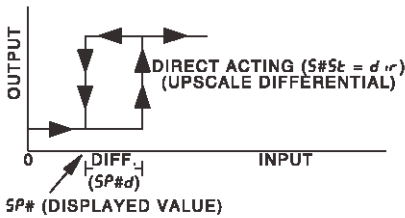

##tP Time Proportioning Cycle Time. Select *1tP* to *80tP*.

1tP A setting of 1tP is recommended for solid state outputs (SSR or 15VDC).

2tP to **80tP** Time Proportioning Control is adjustable in 1 second steps. Recommended for mechanical outputs (relays, solenoids, etc.). For best contact life, a time should be selected as long as possible without causing the process to wander.

#PUL Pulsed Time Proportioning Output: Select *1PUL* to *7PUL*. *1PUL* = Linear and *7PUL* = most nonlinear. Changes output linearity for use in cooling applications or for extremely fast response processes. At the center of the proportional band, a pulse value of 1 provides an output of one second on and one second off (50% output). A pulse value of 2 provides an output of one second on and two seconds off (33% output). Output at center of band equals one second on, $2^{(\text{pulse value}-1)}$ seconds off.

Prop For Current (Code 5) outputs only.

The following menu items apply only if your control is equipped with a second set point (last digit of model number is not zero). If your control does not have a second set point, jump to the $\epsilon_{\text{UN}}\epsilon$ menu on the next page.

- Out2** Output selection: Select OnOF, #tP, #PUL, or ProP.
- OnOF** A setting of **OnOF** allows the control to operate in simple on/off mode. This setting forces the control to turn off at set point, and on at the set point plus the differential (**SP2d**). When selected, the **Out2/OnOF** menu item is followed by ##### **SP2d**, and the **Pb2** selection in the Secondary menu and the **520L** and **520H** selections in the Secure menu are suppressed.
- SP2d** Set Point On-Off Differential (hysteresis). Select **!** to **9999** (direct acting), or **-!** to **-9999** (reverse acting). See **SP1d** on the previous page.
- ##tP** Time Proportioning Cycle Time. Select **tP** to **80tP**.
- tP** A setting of **tP** is recommended for solid state outputs (SSR or 15VDC).
- 2tP** to **80tP** Time Proportioning Control is adjustable in 1 second steps. Recommended for mechanical outputs (relays, solenoids, etc.). For best contact, life, a time should be selected as long as possible without causing the process to wander.
- #PUL** Pulsed Time Porportioning Output: Select **!PUL** to **7PUL**.
!PUL = Linear and **7PUL** = most nonlinear. Changes output linearity for use in cooling applications or for extremely fast response processes. At the center of the proportional band, a pulse value of 1 provides an output of one second on and one second off (50% output). A pulse value of 2 provides an output of one second on and two seconds off (33% output). Output at center of band equals one second on, 2(pulse value -1) seconds off.
- ProP** For Current (Code 5) outputs only.

SP (Option 948, 4-Stage Set Point) Active Set Point Stage. Select **1SP 1**, **2SP 1**, **3SP 1**, **4SP 1**. (See Page 17 for more detail.)

1SP 1 Set Menu Items to display Stage 1 for view and change access. If **SP5A** is set for **Int**, **1SP 1** is made active.

2SP 1 Set Menu Items to display Stage 2 for view and change access. If **SP5A** is set for **Int**, **2SP 1** is made active.

3SP 1 Set Menu Items to display Stage 3 for view and change access. If **SP5A** is set for **Int**, **3SP 1** is made active.

4SP 1 Set Menu Items to display Stage 4 for view and change access. If **SP5A** is set for **Int**, **4SP 1** is made active.

#SP 1 (Option 948, 4-Stage Set Point) Adjust Control Point 1 for Stage selected above.

Note: The menu items for **tunE** (below) are modified when Option 948 is active. Then, the menu items are shortened or shifted right, and preceded with the stage number selected in **SP** above. Each stage has its own set of **tunE** parameters as indicated by **#tun**.

#tun tunE (Option 948, 4-Stage Set Point) or Tuning Choice: Select **SELF**, **P id**, **SLD**, **nor**, or **FRSt**.

SELF The Controller will evaluate the Process and select the PID values to maintain good control. Active for SP1 only.

LErn Select **YES** or **no**

YES Start Learning the Process. After the process has been learned the menu item will revert to **no**.

no Learning will stay in present mode.

dFRC Damping factor, select **OFF**, **1** to **7**. Sets the ratio of Rate to Rate for the **SEltunE** mode. **7** = most Rate. Factory set to **3**. For a fast response process the value should be lowered (less Rate). For a slower process the value should be increased (more Rate).

P id Manually adjust the PID values. PID control consists of three basic parameters, Proportional Band (Gain), Reset Time (Integral), and Rate Time (Derivative).

Pb 1 Proportional Band (Bandwidth). Select **1** to **9999**°F, °C, or counts.

Pb2 Proportional Band (Bandwidth). Select **1** to **9999**°F, °C, or counts. Appears only if control is equipped with second set point and **Out2** is NOT selected as **OnOF**.

rES Automatic Reset Time. Select *OFF*, *0.1* to *99.9* minutes. Select *OFF* to switch to *OFFS*.

OFFS Manual Offset correction Select. Select *OFF*, *0.1* to *99.9* percent. Select *OFF* to switch to *rES*.

rTE Rate Time. Select *OFF*, *0.1* to *99.9* minutes. Derivative.

SLO PID values are preset for a slow response process.

nor PID values are preset for a normal response process.

FAST PID values are preset for a fast response process.

Pid2 Linkage of PID parameters between SP1 and SP2: Select *On* or *OFF*.

On Applies SP1 *rES*, *rTE*, *Fbnd*, and *FrtE* terms to SP2 for heat/cool applications

OFF SP2 functions without *rES*, *rTE*, *Fbnd*, and *FrtE*.

ARUP Anti- Reset Windup Feature: Select *On* or *OFF*.

On When *ARUP* is *On* the accumulated Reset Offset value will be cleared to 0% when the process input is not within the Proportional Band.

OFF When *ARUP* is *OFF*, the accumulated Reset Offset value is retained in memory when the process input is not within the Proportional Band.

ArtE Approach Rate Time: Select *OFF*, *0.1* to *99.99* minutes. The function defines the amount of Rate applied when the input is outside of the Proportional Band. The *ArtE* time and the *rTE* time are independent and have no effect on each other. To increase damping effect and reduce overshoot set the approach rate time for a value greater than the natural rise time of the process (natural rise time = process value time to set point).

Fint Fuzzy Logic Intensity: Select *0* to *100%*. 0% is OFF (disables Fuzzy Logic). The function defines the amount of impact Fuzzy Logic will have on the output.

Fbnd Fuzzy Logic Error Band: Select *0* to *4000* °F, °C, or counts. Sets the band width of the Fuzzy Logic. Set *Fbnd* equal to PID proportional band (*Pb*) for best results.

FrtE Fuzzy Logic Rate of Change: Select *0.00* to *99.99* counts/second. For best initial setting, find the counts/second change of process value near Set Point 1 with output ON 100%. Multiply this value by 3. Set **FrtE** to this calculated value.

PER The Peak feature stores the highest input the control has measured since the last reset or Power On. At Power On **PER** is reset to the present input. To manually reset the value **PER** must be in the lower display. Press the **ENTER** key to reset. **PER** will be reset and display the present input value.

VAL The Valley feature stores the lowest input the Instrument has measured since the last reset or Power On. At Power On **VAL** is reset to the present input. To manually reset the value **VAL** must be in the lower display. Press the **ENTER** key. **VAL** will be reset and display the present input value.

PctO Percent Output Feature: Select *On* or *OFF*.

On When selected *On*, the HOME lower display will indicate the output of the controller in percent. An “o” will appear in the right hand side of the lower display to indicate percent output for SP1. An “o” will appear on the right hand corner of the lower display to represent percent output for SP2, if the control is so equipped. The display will alternate between these values.

OFF Percent Output display is disabled.

Prog **Ramp/Soak Feature (16A3):** Select *On* or *OFF*.

On **Allows Programmed Ramp/Soak function to be started by the Run/Hold key on the control front panel.**

OFF **Turns Ramp/Soak function *OFF* and resets program to beginning.**

PSEt **Programmer function set (16A3):** Select *On* or *OFF*.

OFF **Skip Ramp/Soak Programming. Go to next Secondary Menu Item, *InPE* on the next page.**

On **Enable Ramp/Soak Programming.**

StAt **Programmer Status Display in the Primary Menu when Prog (above) is On (16A3):** Select *On* or *OFF*.

OFF **The Primary Menu operates as normal.**

On **The Primary Menu is altered to have the following items inserted before the SP1 menu item:**

t , **time remaining in active segment**

##t , **total time in active segment**

##SP **segment target set point**

- tbRS* **Ramp/Soak Time Base (16A3):** Select *1.5* or *60.5*.
- 1.5* **Ramp/Soak time base is in 1 second increments. Program time *t*, ... *16t*, is measured in seconds.**
- 60.5* **Ramp/Soak time base is in 60 second increments (minutes). Program time *t*, ... *16t*, is measured in minutes.**

The following items repeat in the following order: *t*, *1SP*, *1A1* (if *AL1* is programmed as *Event*), *2t*, *2SP*, *2A1*, . . . , *16t*, *16SP*, *16A1*. To avoid repetition each item will only be described once.

- t*, **Segment Time (16A3):** Select *0* to *9999* units (minutes if *tbRS* is set to *60.5*, seconds if *tbRS* is set to *1.5*).
- 1SP* **Segment Set Point (16A3):** Set to target value desired.
- 1A1* **Segment Alarm 1 Event (16A3):** Select *On* or *OFF*.
- On* **Alarm 1 is active during segment 1 time (*t*).**
- OFF* **Alarm 1 is inactive during segment 1 time (*t*).**
- PEnd* **Program End Action (16A3):** Select *Hold* or *Off*.
- Hold* **Stay at the Present Set Point (*16SP*).**
- Off* **Turn Off SP1 and SP2 Outputs at the end of the program.**
- Loop* **Repeat program starting at *t*.**
- SP1* **Revert to *SP1* value.**

inPC **Input Correction:** Select *-500* to *0* to *500* °F, °C, or counts. This feature allows the input value to be changed to agree with an external reference or to compensate for sensor error. **Note:** *inPC* is reset to zero when the input type is changed, or when decimal position is changed. Factory default is *0*.

Filt **Digital Filter:** Select *OFF*, *1* to *99*. In some cases the time constant of the sensor, or noise, could cause the display to jump enough to be unreadable. A setting of 2 is usually sufficient filtering (2 represents approximately a 1 second time constant). When the 0.1 degree resolution is selected this should be increased to 4. If this value is set too high, controllability will suffer.

LPbr Loop Break Protection: Select **OFF**, 1 to **9999** seconds. If, during operation, the output is minimum (0%) or maximum (100%), and the input moves less than 5°F (3°C) or 5 counts over the time set for **LPbr**, the **LOOP BRK** message will appear. This condition can also be routed to an Alarm Condition if alarms are present and turned On (see **ALbr** in the Secure Menu). The loop break error can be reset by pressing the **ENTER** key when at the **LPbr** menu item. The **INDEX & ENTER** keys may also be used.

LR-E (Option 992, 993, 995, 996, Serial Communications) Local / Remote Status: Select **LR-E** or **r-E**. Does not affect other instruments on daisy chain.

LR-E The host computer is advised that remote write commands will be rejected. Any write commands sent to this control will be rejected. All read commands are accepted.

r-E The host computer is allowed to send write commands. If the control is not addressed within the time set in **NA-E** (No Activity Timer in the Secure Menu) the **CHCC LR-E** error message will be displayed.

POL (Option 934, 936, Analog Retransmission Output) Process Output Low: Select -450°F, -260°C, or -1999 counts to any value less than **POH**.

POH (Option 934, 936, Analog Retransmission Output) Process Output High: Select from any value greater than **POL** to + 9999°F, +5530°C, or 9999 counts.

POSr (Option 934, 936, Analog Retransmission Output) Process Output Source: Select **INP** or **SP1**.

INP Process output follows the Process Variable (input).

SP1 Process output follows the Set Variable (SP1).

Addr (Option 992, 993, 995, 996 Serial Communications) Control Address: Set from 1 to 3FF (Options 992 and 993) or set from 1 to FF (Options 995 and 996). This number (hexadecimal, base 16) must match the address number used by the host computer. Not settable in this menu. To change this parameter, see Addr in the Secure Menu.

SECURE MENU

Hold **▲** **↵** UP ARROW & ENTER for 5 Seconds. Press **◀** INDEX to advance to the next menu item. Press **▲** **▼** UP ARROW or DOWN ARROW to change the value in the display. Press **↵** ENTER to retain the value.

OUTPUTS ARE DISABLED (TURNED OFF) WHILE CONTROL IS IN SECURE MENU.

SECr Security Code: See the Security Level Selection and the Password Table in this manual, in order to enter the correct password.

inP Input Type: Select one of the following. Refer to the Wiring section for the proper wiring.

- J- 1C** Type "J" Thermocouple
- KA** Type "K" Thermocouple
- E-** Type "E" Thermocouple
- t-** Type "T" Thermocouple
- L-** Type "L" Thermocouple
- n-** Type "N" Thermocouple
- r- 13** Type "R" Thermocouple
- S- 10** Type "S" Thermocouple
- b-** Type "B" Thermocouple
- C-** Type "C" Thermocouple
- P392** 100 ohm Platinum (NIST 0.00392 $\Omega / \Omega / ^\circ\text{C}$)
- n 120** 120 ohm Nickel
- P385** 100 ohm Platinum (IEC/DIN 0.00385 $\Omega / \Omega / ^\circ\text{C}$)
- 1P38** 1000 ohm Platinum (IEC/DIN 0.00385 $\Omega / \Omega / ^\circ\text{C}$)
- Curr** DC Current Input 0.0 to 20.0 or 4.0 to 20.0 mA.
- Volt** DC Voltage Input 0.0 to 10.0 or 1.0 to 10.0 volts.
- d iFF** DC Voltage Input -10 to +10 mV.
- - - -** Reserved

0SUP Zero Suppression: Select On or OFF. Only with Current and Voltage input types.

OFF The input range will start at 0 (zero) Input.

On The input range will start at 4.00 mA or 1.00 V.

Unit *F*, *C* or *nonE*.

F °F descriptor is On and temperature inputs will be displayed in actual degrees Fahrenheit.

C °C descriptor is On and temperature inputs will be displayed in actual degrees Celsius.

nonE °F and °C descriptors will be Off. This is only available with Current and Voltage Inputs.

dPt Decimal Point Positioning: Select *0*, *0.0*, *0.00*, *0.000*, or *0.0000*. On temperature type inputs a change here will alter the Process Value, SP1, SP2, ALLO, ALHi, and InPC. For current and voltage Inputs all Menu Items related to the Input will be affected.

0 No decimal Point is selected. This is available for all Input Types.

0.0 One decimal place is available for Type J, K, E, T, L, RTD's, Current and Voltage Inputs.

0.00 Two decimal places is only available for Current and Voltage Inputs.

0.000 Three decimal places is only available for Current and Voltage inputs.

0.0000 Four decimal places is only available for Current and Voltage inputs.

inPt Input Fault Timer: Select *OFF*, *0.1* to *540.0* minutes. Whenever an Input is out of range (*UFL* or *OFL* displayed), shorted, or open, the timer will start. When the time has elapsed, the controller will revert to the output condition selected by *inPb* below. If *OFF* is selected, the Input Fault Timer will not be recognized (time = infinite).

inPb **Input Fail Action (16A3): Select *FR IL*, *AUE*, or *PrE*. When the Input is out of range (*UFL* or *OFL* displayed) and the Input timer (*inPt*) time has elapsed, the controller will revert to the selected condition.**



FR IL **Outputs are disabled (go to 0% output).**

AUE **The outputs will hold at the last known average percentage of output.**

PrE **The outputs will maintain preprogrammed percentages of output as specified in PrE1 and PrE2.**

PrE 1 **Preset output for Set Point 1. Select 0 to 100%.**

PrE 2 **Preset output for Set Point 2. Select 0 to 100%.**

- RPCL** **Manual and PctO display adjustment (16A3).** Select *rERL* or *Adj.*
- rERL* **Manual display will display output 0 to 100% relative to actual range of the output.**
- Adj* **Manual display will display output 0 to 100% relative to the S#OL and S#OH settings.**
- SEnC** Sensor Rate of Change: Select *OFF*, 1 to 4000 °F, °C, or counts per 1 second period. This value is usually set to be slightly greater than the fastest process response expected during a 1 second period, but measured for at least 2 seconds. If the process is faster than this setting, the *SEnC bAd* error message will appear. The outputs will then be turned off. This function can be used to detect a runaway condition, or speed up detection of an open thermocouple. Use the   **INDEX & ENTER** keys to reset.
- SCAL** Scale Low: Select 100 to 11998 counts below *SCRH*. The total span between *SCAL* and *SCRH* must be within 11998 counts. Maximum setting range is -1999 to +9999 counts. For Current and Voltage inputs, this will set the low range end. Value not adjustable for Thermocouple and RTD ranges.
- SCRH** Scale High: Select 100 to 11998 counts above *SCAL*. The total span between *SCAL* and *SCRH* must be within 11998 counts. Maximum setting range is -1999 to +9999 counts. For Current and Voltage inputs, this will set the high range end. Value not adjustable for Thermocouple and RTD ranges.
- SPL** Set Point Low: Select from the lowest input range value to *SPH* value. This will set the minimum SP1 or SP2 value that can be entered. The values for SP1 or SP2 will stop moving when this value is reached.
- SPH** Set Point High: Select from the highest input range value to *SPL* value. This will set the maximum SP1 or SP2 value that can be entered. The values for SP1 or SP2 will stop moving when this value is reached.
- SP 10** Set Point 1 Output Select: Select *Outa* or *Outb*.
- Outa* Set Point 1 is routed through Output A, Set Point 2 (if equipped) is routed through Output B.
- Outb* Set Point 1 is routed through Output B, Set Point 2 (if equipped) is routed through Output A.

S 1St Set Point 1 state : Select **d ir** or **rE**.

d ir Direct Action. As the input increases the output will increase. Most commonly used in cooling processes.

rE Reverse Action. As the input increases the output will decrease. Most commonly used in heating processes.

If **Out 1** (Page 21) is set for **##tP**, **#PUL**, or **Prop**, then **S 1OL** and **S 1OH** appear. If **Out 1** is set for **OnOF**, then skip **S 1rE**.

S 1OL Set Point Output Low Limit. Select 0 to 100% but not greater than **S 1OH**. This item limits the lowest output value. This is useful for adding a bias to the process when needed. Factory set to 0 for outputs codes 1, 2, 3, 4, and 8. Factory set to 20 for output code 5 (20% output equals 4 mA output).

S 1OH Set Point 1 Output High Limit. Select 0 to 100% but not less than **S 1OL** for output codes 1, 2, 3, 4, or 8. Select 0 to 102% but not less than **S 1OL** for output code 5. This item allows setting the maximum output limit. This is useful with processes that are over powered. Adjustment to 102% allows setting current output to force a full on condition for output devices which do not have bias adjustments. Factory set to 100 for all output codes.

If **Out 1** is set for **##tP**, **#PUL**, or **Prop**, then skip to **S 1LP** below.

If **Out 1** is set to **OnOF** (in Secondary Menu), then the next three menu items can make the **SP 1** and **SP 1d** settings act like a high or low alarm set point. See the information on alarm settings and the cautions and warnings that apply to them on Pages 30-31.

Note that when Set Point 1 Power Interrupt, **S 1P**, is On, and Set Point 1 Reset, **S 1rE**, is programmed to **Hold**, the **SP 1** output will automatically reset upon a power failure and subsequent restoration, if the process is below **SP 1**.

S 1rE Set Point 1 Reset. Select **OnOF** or **Hold**.

OnOF Output will automatically reset when process passes back through **SP 1d**.

Hold Manual Reset. Reset by simultaneously pressing the   **INDEX & DOWN ARROW** keys for 3 seconds.

SP1 Set Point 1 Power Interrupt. Select **On** or **OFF**.
On Alarm Power Interrupt is **On**. Output will automatically reset on power-up if no alarm condition exists.
OFF Alarm Power Interrupt is **OFF**. Output will be in the alarm condition on power-up regardless of condition of process.

SP1IH Set Point 1 Inhibit: Select **On** or **OFF**.
On Alarm Inhibit is On. Alarm action is suspended until the process value first enters a non-alarm condition.
OFF Alarm Inhibit is OFF.

SP1LP Set Point Lamp: Select **On** or **Off**.
On Lamp ON when Output is ON.
Off Lamp OFF when Output is ON.

If your control is not equipped with Set Point 2, then proceed to the alarm section (next page).

SP2t Set Point 2 type: Select **ABS** or **DE**.
ABS Absolute **SP2**. **SP2** is independent of **SP1**, and may be set anywhere between the limits of **SPL** and **SPH**.
DE Deviation **SP2**. **SP2** is set as a deviation from **SP1**, and allows **SP2** to retain its relationship with **SP1** when **SP1** is changed (**SP2** tracks **SP1**).

SP2St Set Point 2 State: Select **dir** or **rev**.
dir Direct Action. As the input increases the output will increase. Most commonly used in cooling processes.
rev Reverse Action. As the input increases the output will decrease. Most commonly used in heating processes.

If **Out2** is set for **##tP**, **#PUL**, or **Prop**, then **S20L** and **S20H** appear. If **Out2** is set for **On OFF**, then skip **S20L** and **S20H**.

S20L Set Point Output Low Limit: Select 0 to 100% but not greater than **S20H**. This item limits the lowest output value. This is useful for adding a bias to the process when needed. Factory set to 0 for output codes 1,2, 3, 4, and 8. Factory set to 20 for output code 5 (20% output equals 4 mA output).

S20H Set Point 2 Output High Limit: Select 0 to 100% but not less than **S20L** for output codes 1, 2, 3, 4, or 8. Select 0 to 102% but not less than **S20L** for output code 5. This item allows setting the maximum output limit. This is useful with processes that are over powered. Adjustment to 102% allows setting current output to

force a full on condition for output devices which do not have bias adjustments. Factory set to **100** for all output codes.

If **Out2** is set to **OnOF** (in the Secondary Menu), then the next three menu items can make the SP2 and SP2d settings act like a high or low alarm set point. See the information on alarm settings and the cautions and warnings that apply to them on the next pages.

Note that when Set Point 2 Power Interrupt, **SP2P**, is On, and Set Point 2 Reset, **SP2R**, is programmed to Hold, the **SP2** output will automatically reset upon a power failure and subsequent restoration, if the process is below **SP2**.

SP2R Set Point 2 Reset. Select **OnOF** or Hold.

OnOF Output will automatically reset when process passes back through **SP2d**.

Hold Manual Reset. Reset (acknowledge) by simultaneously pressing the **↶** **INDEX** & **DOWN ARROW** keys for 3 seconds.

SP2P Set Point 2 Power Interrupt. Select On or OFF.

On Alarm Power Interrupt is On. Output will automatically reset on power-up if no alarm condition exists.

OFF Alarm Power Interrupt is OFF. Output will be in the alarm condition on power-up regardless of condition of process.

SP2IH Set Point 2 Inhibit: Select On or OFF.

On Alarm Inhibit is On. Alarm action is suspended until the process value first enters a non-alarm condition.

OFF Alarm Inhibit is OFF.

SP2LP Set Point 2 Lamp: Select On or OFF.

On Lamp ON when Output is ON.

OFF Lamp OFF when Output is ON.

ALARM TYPE AND ACTION (if alarm function is present)



Caution: In any critical application where failure could cause expensive product loss or endanger personal safety, a redundant limit controller is required.

When setting an alarm value for an absolute alarm ($A1t = AbS$), simply set the value at which the alarm is to occur. When setting the alarm value for a deviation alarm ($A1t = dE$), set the difference in value from the Set Point desired. For

example if a low alarm is required to be 5 degrees below the Set Point, then set A1Lo to -5. If a high alarm is required 20 degrees above the Set Point, then set A1Hi to +20. If the Set Point is changed, the alarm will continue to hold the same relationship as originally set.

The diagram below shows the action and reset functions for both absolute and deviation alarms.

D = 1 degree F, 1 degree C, or 1 count.

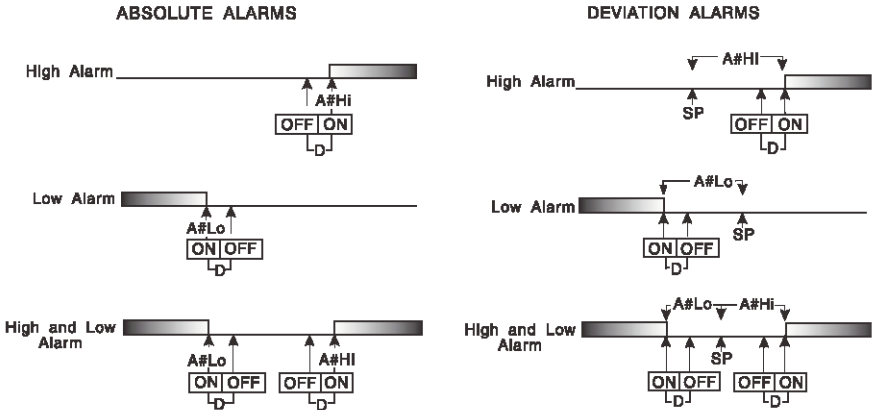

Note that when Alarm Power Interrupt, A1Pi, is programmed ON and Alarm Reset, A1rE, is programmed for Hold, the alarm will automatically reset upon a power failure and subsequent restoration if no alarm condition is present.

If Alarm Inhibit, A1iH, is selected ON, an alarm condition is suspended upon power up until the process value passes through the alarm set point once. Alarm inhibit can be restored as if a power up took place by pressing both the  **INDEX** and **ENTER** keys for 3 seconds.





WARNING: IF INHIBIT IS ON AND A POWER FAILURE OCCURS DURING A HIGH ALARM, RESTORATION OF POWER WILL NOT CAUSE THE ALARM TO OCCUR IF THE PROCESS VALUE DOES NOT FIRST DROP BELOW THE HIGH ALARM SETTING. DO NOT USE THE ALARM INHIBIT FEATURE IF A HAZARD IS CREATED BY THIS ACTION. BE SURE TO TEST ALL COMBINATIONS OF HIGH AND LOW ALARM INHIBIT ACTIONS BEFORE PLACING CONTROL INTO OPERATION.

The following menu items apply only to the alarm.

- AL1** Alarm 1 function: Select *OFF*, *Lo*, *H*, *HLo*, or *EUnt*.
- OFF** Alarm 1 is disabled. No Alarm 1 menu items appear in the Secondary or Secure menus.
- Lo** Low Alarm Only. **RLo** appears in the Secondary Menu.
- H** High Alarm Only. **RH** appears in the Secondary Menu.
- HLo** High and Low Alarms. Both **RLo** and **RH** appear in the Secondary Menu, and share the same Alarm 1 Relay output.
- EUnt** **Alarm 1 is controlled by the Ramp/Soak program function. (16A3). See Pages 11-14 and 26 (#A1) for further information.**

If **AL1** is set to *OFF* and the control is not equipped with options, the Secure Menu ends here. If **AL1** is set to *OFF* and the control is equipped with options, proceed to *SPSR*, *Addr*, or *rSCL* below.

If **AL1** is set to *EUnt*, go to **R1St** below.

- ALt** Alarm 1 Type: Select *AbS* or *dE*
- AbS** Absolute Alarm that may be set anywhere within the values of *SCAL* and *SCRH* and is independent of *SP1*.
- dE** Deviation Alarm that may be set as an offset from *SP1*. As *SP1* is changed the Alarm Point will track with *SP1*.
- ALrE** Alarm 1 Reset: Select *OnDF* or *Hold*.
- OnDF** Automatic Reset.
- Hold** Manual Reset. Reset (acknowledge) by simultaneously pressing the   **INDEX & DOWN ARROW** keys for 3 seconds.
- ALP** Alarm 1 Power Interrupt: Select *On* or *OFF*.
- On** Alarm Power Interrupt is *On*.
- OFF** Alarm Power Interrupt is *OFF*.
- ALiH** Alarm 1 Inhibit: Select *On* or *OFF*.
- On** Alarm Inhibit is *On*. Alarm action is suspended until the process value first enters a non-alarm condition.
- OFF** Alarm Inhibit is *OFF*.
- R1St** Alarm 1 Output State: Select *CLOS* or *OPEN*.
- CLOS** Closes Contacts at Alarm Set Point.
- OPEN** Opens Contacts at Alarm Set Point.

- ALP** Alarm 1 Lamp: Select **On** or **Off**.
- On** Alarm Lamp is ON when alarm contact is closed.
 - Off** Alarm Lamp is OFF when alarm contact is closed.
- ALB** Alarm 1 Loop Break. Select **On** or **Off**.
- On** Loop Break Condition will cause an Alarm Condition.
 - Off** Loop Break will not affect the Alarm Condition.
- Addr** (Option 992, 993, 995, 996, Serial Communications) Control Address: Set from **1** to **3FF** for Options 992 and 993. Set from **1** to **FF** for options 993 and 995. This number (hexadecimal, base 16) must match the address number used by the host computer. Power to instrument must be turned off and on before change takes effect (see Page14).
- BAUD** (Option 992, 993, 995, 996, Serial Communications) Communication Baud Rate: Select **300**, **1200**, **2400**, **4800**, **9600** (baud), **19.2**, **28.8**, or **57.6** (kbaud) for Options 992 and 993. Select 300, 1200, 2400, 4800, 9600 (baud) or 19.2 (kbaud) for Options 995 and 996. This number must match the baud rate used by the host computer. Power to instrument must be turned off and on before change takes effect (see Page 14).
- NAT** (Option 992, 993, 995, 996, Serial Communications) No Activity Timer: Select **Off** or **1** to **99** minutes.
- 1- 99** Maximum time between host computer accesses. If timer counts to 0, **CHECK LOGS** will be displayed.
 - Off** No Activity Timer function is disabled.
- Stor** (Option 992, 993, 995, 996 Serial Communications) Store to EEPROM: Select **YES** or **no**. (See additional information on page 18).
- YES** Menu Items changes made through the Serial Communications are stored directly to the EEPROM.
 - no** Menu items changes made through the Serial Communications are stored directly in RAM.

NOTES

ERROR MESSAGES

Any error message may be cleared by using the 'Global Reset' by pressing and holding the   INDEX & ENTER keys for five seconds.

DISPLAY	MEANING	SP OUTPUTS	ACTION REQUIRED
<i>Ar-ER</i> (Alternates with PV)	This message appears if the ambient temperature of the control approaches the ends of tolerance.	Set point outputs active. Alarm active.	Correct the ambient temperature conditions. Ventilate the area of the cabinet or check for clogged filters. If internal temperature sensor is broken (<i>RJC located in terminal 2</i>), return to service.
<i>Ar-ER</i>	This message appears if the ambient temperature of the control is out of range or RJC sensor is broken.	Set point outputs active. Alarm active.	Correct the ambient temperature conditions. Ventilate the area of the cabinet or check for clogged filters. If internal temperature sensor is broken, return for service.

ERROR MESSAGES

Any error message may be cleared by using the 'Global Reset' by pressing and holding the   INDEX & ENTER keys for five seconds.

DISPLAY	MEANING	SP OUTPUTS	ACTION REQUIRED
<p><i>UFL</i> or <i>OFL</i></p> <p><i>bAd</i> <i>InP</i></p> <p><i>OPEn</i> <i>InP</i></p>	<p>Underflow or Overflow: Process value has exceeded input range ends.</p> <p><i>UFL</i> or <i>OFL</i> will sequence to display one of these messages if the InPt is set for a time value.</p> <p>For RTD inputs RTD is open or shorted. For THERMOCOUPLE inputs thermocouple is open.</p>	<p>Set point outputs active. Alarm active.</p> <p>Set point outputs inactive. Alarm active.</p>	<p>May be normal if Input signals go above or below range ends. If not the case, check sensor, input wiring and correct.</p> <p>When <i>InPt</i> (input fault timer) has been set for a time, the outputs will be turned off after the set time. Setting the time to <i>OFF</i> causes the outputs to remain active, however <i>UFL</i> or <i>OFL</i> will still be displayed.</p> <p>Correct or replace sensor.</p> <p>Clear with 'Global Reset'.</p>
<p><i>LOOP</i> <i>bAd</i></p>	<p>The sensor may be defective, heater fuse open, heater open, or the final power output device is bad.</p>	<p>Set point outputs inactive. Alarm active.</p>	<p>Correct or replace sensor, or any element in the control loop that may have failed. Correct the problem.</p>
<p><i>SEnC</i> <i>bAd</i></p>	<p>Sensor Rate of Change exceeded the programmed limits set for <i>SEnC</i>.</p>	<p>Set point outputs inactive. Alarm active.</p>	<p>Check for the cause of the error. The value setting may be too slow for the process, or the sensor is intermittent. Correct the problem.</p>
<p><i>CHEC</i> <i>CAL</i></p>	<p>Check calibration appears as an alternating message if the instrument calibration nears tolerance edges.</p> <p>Check calibration appears as a flashing message if the instrument calibration exceeds specification.</p>	<p>Set point outputs inactive. Alarm active.</p> <p>Set point outputs inactive. Alarm active.</p>	<p>Remove the instrument for service and / or recalibration.</p> <p>Remove the instrument for service and / or recalibration.</p>

ERROR MESSAGES

Any error message may be cleared by using the 'Global Reset' by pressing and holding the   INDEX & ENTER keys for five seconds.

DISPLAY	MEANING	SP OUTPUTS	ACTION REQUIRED
No display lighted	Display is blank. Instrument is not getting power, or the supply voltage is too low.	Set point outputs inactive. Alarm inactive	Check that the power supply is on, measure supply voltage, check that the external fuses are good.
<i>FR IL tEst</i>	Fail test appears upon power up if the internal diagnostics detect a failure. This message may occur during operation if a failure is detected. Displays flash. Fail test may also occur due to an EEPROM error.	Set point outputs inactive. Alarm inactive	The display alternates between <i>FR IL tEst</i> and one of the following messages: <i>FRct dFLt</i> : Memory may be corrupted. Restore to the factory default settings. Recheck controller programming. <i>rEt FRct</i> : Unrecoverable error. Return to service.
<i>CHEC SP 1, CHEC SP 2, CHEC ISP, ..., CHEC ISSP</i>	This message will appear upon power up if <i>SP 1</i> , <i>SP 2</i> , <i>#SP 1</i> , or <i>##SP</i> is set outside of the <i>SPL</i> or <i>SPH</i> values.	Set point outputs inactive. Alarm active	Correct the <i>SP 1</i> , etc. or adjust the <i>SPL</i> or <i>SPH</i> values by programming new values.
<i>CHEC SPL or CHEC SPH</i>	This message appears at power up if <i>SPL</i> or <i>SPH</i> values are programmed outside the input range ends.	Set point outputs inactive. Alarm active	Correct the <i>SPL</i> or <i>SPH</i> values by programming new values.
<i>CHEC rSPt</i>	This message appears if the analog remote set point signal is out of range.	Set point outputs inactive. Alarm active	The control will revert to <i>SP 1</i> . Correction of the analog signal or turning off the <i>rSPt</i> clears the error message.
<i>CHEC LoRE</i>	This message appears if the Serial Communications has timed out.	Set point outputs inactive. Alarm active	Change the <i>LoRE</i> to <i>LOt</i> . Restore the communications line and switch <i>LoRE</i> back to <i>rE</i> .

SPECIFICATIONS

Selectable Inputs: Thermocouple, RTD, DC Voltage, or DC Current selectable.

Input Impedance:

Thermocouple = 3 megohms minimum. RTD current = 200 μ A.

Current = 10 ohms. Voltage = 5000 ohms.

Sensor Break Protection: De-energizes control output to protect system after customer set time. (See InPt in Secure Menu.)

Set Point Range: Selectable (See Input Ranges Page 43).

Display: Two 4 digit, 7 segment 0.3" high LEDs.

Control Action: Reverse (usually heating), Direct (usually cooling) selectable.

Proportional Band: 1 to 9999 $^{\circ}$ F, $^{\circ}$ C, or counts.

Reset Time (Integral): Off or 0.1 to 99.9 minutes.

Rate Time (Derivative): Off or 0.01 to 99.99 minutes.

Cycle Rate: 1 to 80 seconds.

On - Off Differential: Adjustable 1 $^{\circ}$ F, 1 $^{\circ}$ C, or 1 count to full scale in 1 $^{\circ}$ F, 1 $^{\circ}$ C, or 1 count steps.

Alarm On - Off Differential: 1 $^{\circ}$ F, 1 $^{\circ}$ C, or 1 count.

Fuzzy Percent: 0 to 100%.

Fuzzy Rate: Off or 0.01 to 99.99 counts per second.

Fuzzy Band: Off or 1 to 4000 $^{\circ}$ F, $^{\circ}$ C, or counts.

Accuracy: $\pm 0.25\%$ of span, ± 1 least significant digit.

Resolution: 1 degree or 0.1 degree, selectable.

Line Voltage Stability: $\pm 0.05\%$ over the supply voltage range.

Temperature Stability: 4 μ V/ $^{\circ}$ C (2.3 μ V/ $^{\circ}$ F) typical, 8 μ V/ $^{\circ}$ C (4.5 μ V/ $^{\circ}$ F) maximum (100 ppm / $^{\circ}$ C typical, 200 ppm / $^{\circ}$ C maximum).

Common Mode Rejection: 140 db minimum at 60 Hz.

Normal Mode Rejection: 65 db typical, 60 db at 60 Hz.

Isolation:

Relay and SSR outputs: 1500 Vac to all other inputs and outputs.

SP1 and SP2 Current output: 500 Vac to all other inputs and outputs but not isolated from each other.

SP1 and SP2 Switched Voltage output: 500 Vac to all other inputs and outputs, but not isolated from each other.

Process Output (934, 936): 500 VAC to all other inputs and outputs.

Supply Voltage: 100 to 240 Vac, nominal, +10 -15%, 50 to 400 Hz. single phase; 132 to 240 Vdc, nominal, +10 -20%.

Supply Voltage (Option 9502): 12 to 24 Vdc, Vac 40-400 Hz, $\pm 20\%$.

Power Consumption: 5VA maximum.

Operating Temperature: -10 to +55 $^{\circ}$ C (+14 to 131 $^{\circ}$ F).

Storage Temperature: -40 to +80 $^{\circ}$ C (-40 to 176 $^{\circ}$ F).

Humidity Conditions: 0 to 90% up to 40°C non-condensing, 10 to 50% at 55°C non-condensing.

Memory Backup: Nonvolatile memory. No batteries required.

Control Output Ratings:

SSR: 2.0 A combined outputs A & B @ 240 VAC at 25°C (77°F).
Derates to 1.0 A @ 55°C (130°F).

Relay: SPST, 3 A @ 240 VAC resistive; 1.5A @ 240 VAC inductive; Pilot duty rating 240 VA, 2 A @ 120 VAC or 1 A 240 VAC.

Alarm Relay: SPST, 3 A @ 240 VAC resistive; 1/10 HP @ 120 VAC.

Current (isolated): 0 to 20 mA across 600 ohms maximum.

Switched Voltage (isolated): 15 VDC @ 20 mA.

DC SSR: 1.75 A @ 32 Vdc maximum.

Panel Cutout: 45 mm x 45 mm (1.775" x 1.775").

Depth Behind Mounting Surface: 121.6 mm (4.79") maximum.

Weight: 220 g (8 oz).

Agency Approvals: UL, C-UL E83725; CE.

Front Panel Rating: IP66, (UL Type 4X).

- 992 RS-485 Series Communications**
Port Compliance: EIA-485.
Isolation: 500 VAC.
Protocol: Lovelinks™ II.
Address Range: 001H or 3FFH.
Baud Rates: 300, 1200, 2400, 4800, 9600, 19.2k, 28.8k, 57.6k,
Mode: Half duplex.
Character: 8 bits, 1 start, 1 stop, no parity.
Number of units on line/ports¹: 32.
Cable Lengths¹: 6,000 ft (1,828 m).
Termination: 120 Ohms, balanced.
- 993 RS-232 Series Communications**
Port Compliance: RS-232C.
Isolation: 500 VAC.
Protocol: Lovelinks™ II.
Address Range: 001H or 3FFH.
Baud Rates: 300, 1200, 2400, 4800, 9600, 19.2k, 28.8k, 57.6k.
Mode: Half duplex.
Character: 8 bits, 1 start, 1 stop, no parity.
Number of units on line/ports¹: 1.
Cable Lengths¹: 25 ft (7.6 m).
- 995 RS-232 Series Communications**
Port Compliance: RS-232C.
Isolation: 500 VAC.
Protocol: MODBUS® RTU.
Address Range: 001H or 0FFH.
Baud Rates: 300, 1200, 2400, 4800, 9600, 19.2k.
Mode: Half duplex.
Character: 8 bits, 1 start, 1 stop, no parity.
Number of units on line: 1.
Cable Lengths¹: 25 ft (7.6 m).
- 996 RS-485 Series Communications**
Port Compliance: EIA-485.
Isolation: 500 VAC.
Protocol: MODBUS® RTU.
Address Range: 001H or 0FFH.
Baud Rates: 300, 1200, 2400, 4800, 9600, 19.2k.
Mode: Half duplex.
Character: 8 bits, 1 start, 1 stop, no parity.
Number of units on line/ports¹: 32.
Cable Lengths¹: 6,000 ft (1,828 m).

Termination: 120 Ohms, balanced.

- ¹ Number can be increased through use of a repeater such as the Mother Node™. Consult factory for details.

INPUT RANGES

INPUT TYPE	RANGE °F	RANGE °C
Type J or L ¹ Thermocouple	-100 to +1607	-73 to +871
Type K ¹ Thermocouple	-200 to +2500	-129 to +1371
Type T ¹ Thermocouple	-350 to +750	-212 to +398
Type E ¹ Thermocouple	-100 to +1800	-73 to +982
Type R Thermocouple	0 to 3200	-17 to +1760
Type S Thermocouple	0 to 3200	-17 to +1760
Type B Thermocouple	+75 to +3308	+24 to +1820
Type C Thermocouple	0 to 4208	-17 to +2320
Type N ¹ Thermocouple	-100 to +2372	-73 to +1300
100 Ω Plt. 0.00385 DIN ¹ RTD	-328 to 1607	-200 to +875
100 Ω Plt. 0.00392 NIST ¹ RTD	-328 to 1607	-200 to +875
120 Ω Nickel 0.00628 US ¹ RTD	-112 to +608	-80 to +320
1000 Ω Plt. 0.00385 DIN ¹ RTD	-328 to +1607	-200 to +875
Current/Voltage/ΔVoltage ²	Scalable Units from -1999 to +9999	

- ¹ These Input Types can be set for 0.1° display. If temperature goes above 999.9° or less than -199.9° the display will return to whole degree resolution.
- ² The 0 to 20 mADC, 4 to 20 mADC, 0 to 10 VDC, 2 to 10 VDC, and -10 to +10 mVDC inputs are fully scalable from a minimum of 100 counts span placed anywhere within the range of -1999 to +9999. Decimal point position is adjustable from the zero place (9999), tenths (999.9), hundredths (99.99), thousandths (9.999), or ten thousandths (.9999).

Dimensions

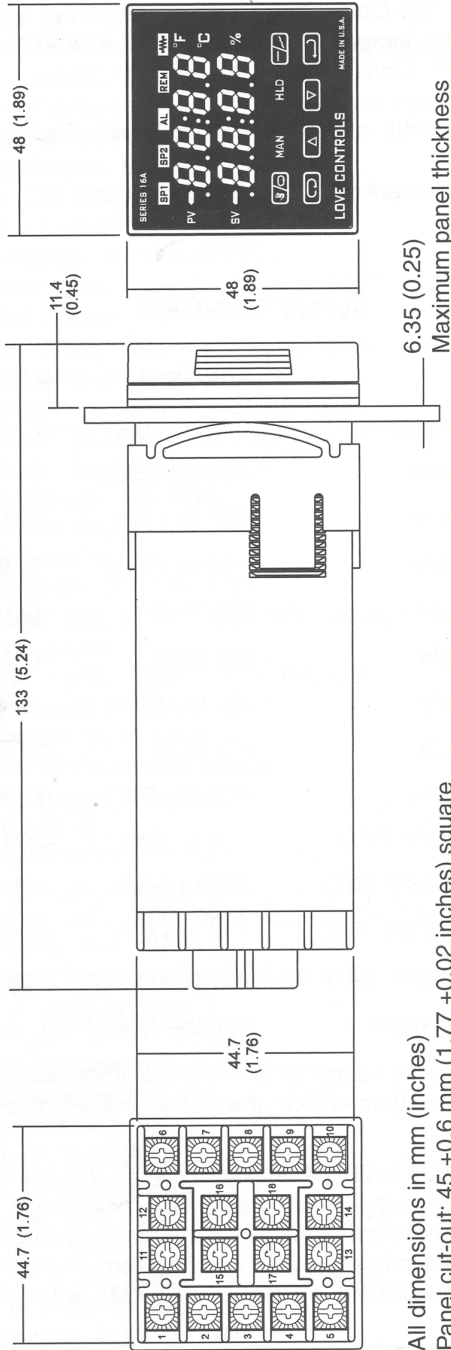

All dimensions in mm (inches)
 Panel cut-out: 45 +0.6 mm (1.77 +0.02 inches) square

