

# MSF Swivel Foot

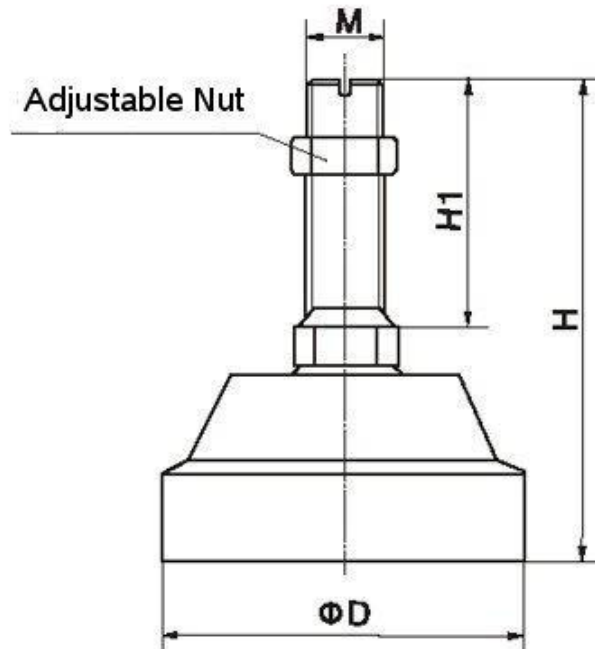

Alloy steel.

Elastomer pad

Height adjustable by rotation

Perfect prevention of unwanted forces

Easy installation, good ability of anti-side loading.

Mainly used for platform scales, floor scales and other electronic weighing devices.

Part Number	Rated Load	Dia D (mm)	H1 (mm)	H (mm)	Thread M	Weight
MSF-M12-2000	2000kg	60	50	92	M12*1.75	0.5kg
MSF-M18-5000	5000kg	80	50	104	M18*1.5	1.0kg
MSF-M24-10000	10000kg	86	50	112	M20*2	2kg